

## DETAILS

<b>Ordering Number</b>	2F11898_STRADA-T-DW-EP
<b>Family</b>	Strada-T
<b>Type</b>	Lens
<b>Color</b>	clear
<b>Diameter</b>	19.6 x 15.5 mm
<b>Height</b>	10.7 mm
<b>Style</b>	rectang
<b>Optic Material</b>	PMMA
<b>Holder Material</b>	
<b>Fastening</b>	screw, glue
<b>Status</b>	ready
<b>ROHS Compliant</b>	Yes
<b>Date Updated</b>	8/03/2014

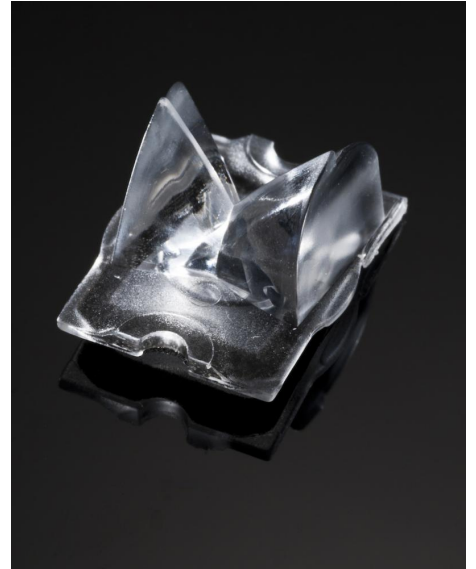

## OPTICAL PROPERTIES

LED	Viewing Angle	Light Beam	Efficiency	cd/lm
XP-E	Asymmetric degrees		92 %	(simulated) 0.000
XP-G	Asymmetric degrees		92 %	(simulated) 0.000
LUXEON Rebel	Asymmetric degrees		92 %	-
LUXEON Rebel ES	Asymmetric degrees		92 %	-
Oslon SSL 80	Asymmetric degrees		92 %	-

D C B A

4

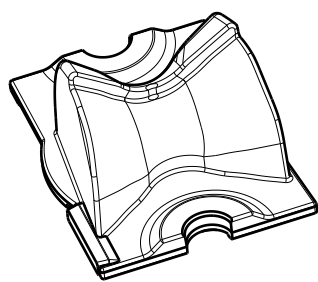

Isometric view

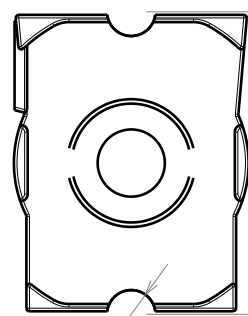

20

fastening

$\varnothing 3.2$

Bottom view

3

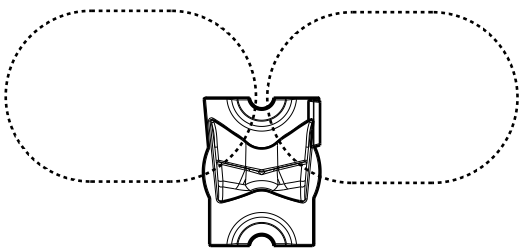

Beam direction

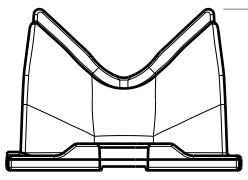

10.7

Front view

2

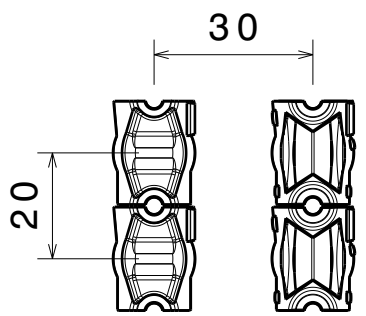

Strada lens arrangement recommendation

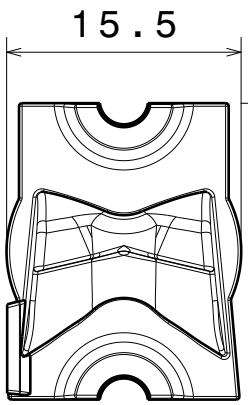

15.5

19.6

Top view

MATERIALS  
 Lens: PMMA  
 Tape(optional): PU Foam

Part no. with tape fastening: CA11993\_Strada-T-DW

This drawing is our property. It can't be reproduced or communicated without our written agreement.



Ledil Oy  
 Tehdaskatu 13  
 FIN-24100 SALO  
 Finland

DRAWING TITLE  
**Datasheet Strada-T-DW-EP Lens**

<b>DRAWN BY</b> pv	<b>DATE</b> 5.9.2011
<b>CHECKED BY</b> jl	<b>DATE</b> 5.9.2011
<b>DESIGNED BY</b> hh	<b>DATE</b> 17.05.2010

<b>SIZE</b> A4	<b>DRAWING NUMBER</b> C11898	<b>REV</b> 1
<b>SCALE</b> 2:1	<b>WEIGHT (g)</b>	<b>SHEET</b> 1/1

1

1

D A

# Ledil Oy C11425\_Strada-T-DW-XP C11425\_Strada-T-DW-XP / LDC (Linear)

Luminaire: Ledil Oy C11425\_Strada-T-DW-XP C11425\_Strada-T-DW-XP  
Lamps: 1 x Cree XP-E (White)

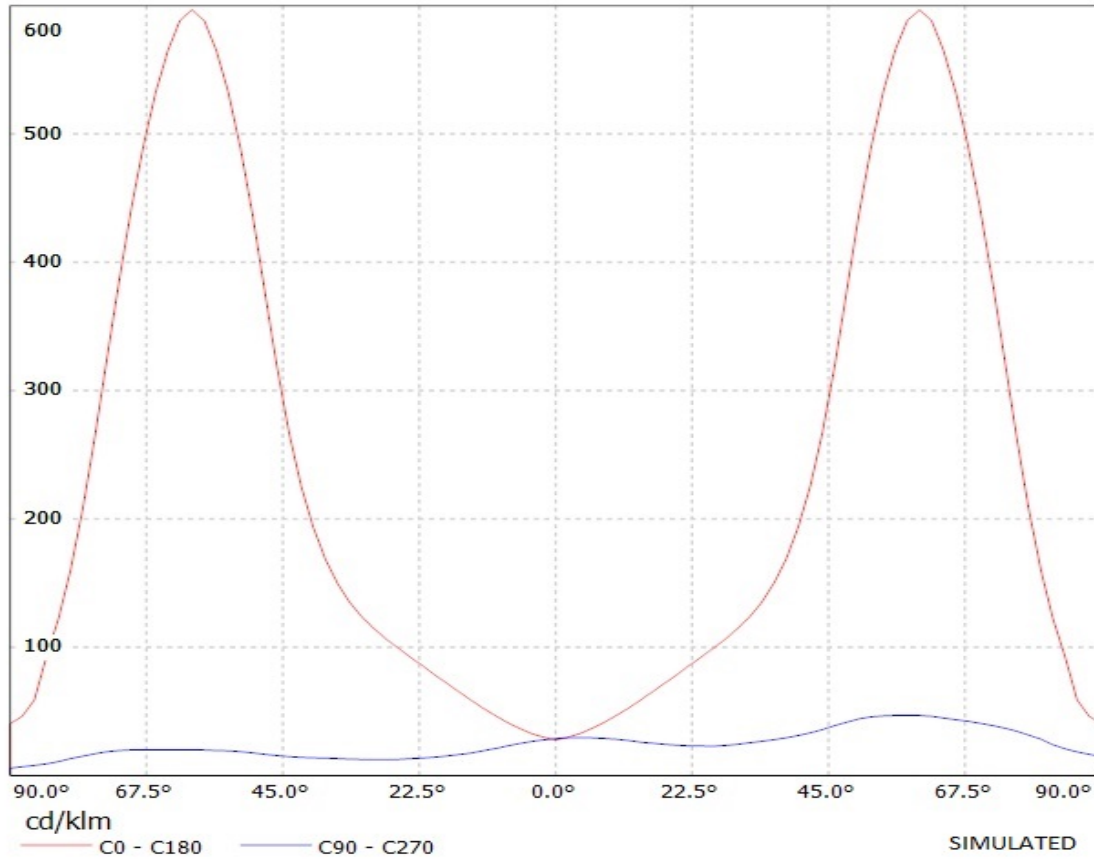

# Ledil Oy C11425\_Strada-T-DW-XP C11425\_Strada-T-DW-XP / LDC (Polar)

Luminaire: Ledil Oy C11425\_Strada-T-DW-XP C11425\_Strada-T-DW-XP

Lamps: 1 x Cree XP-E (White)

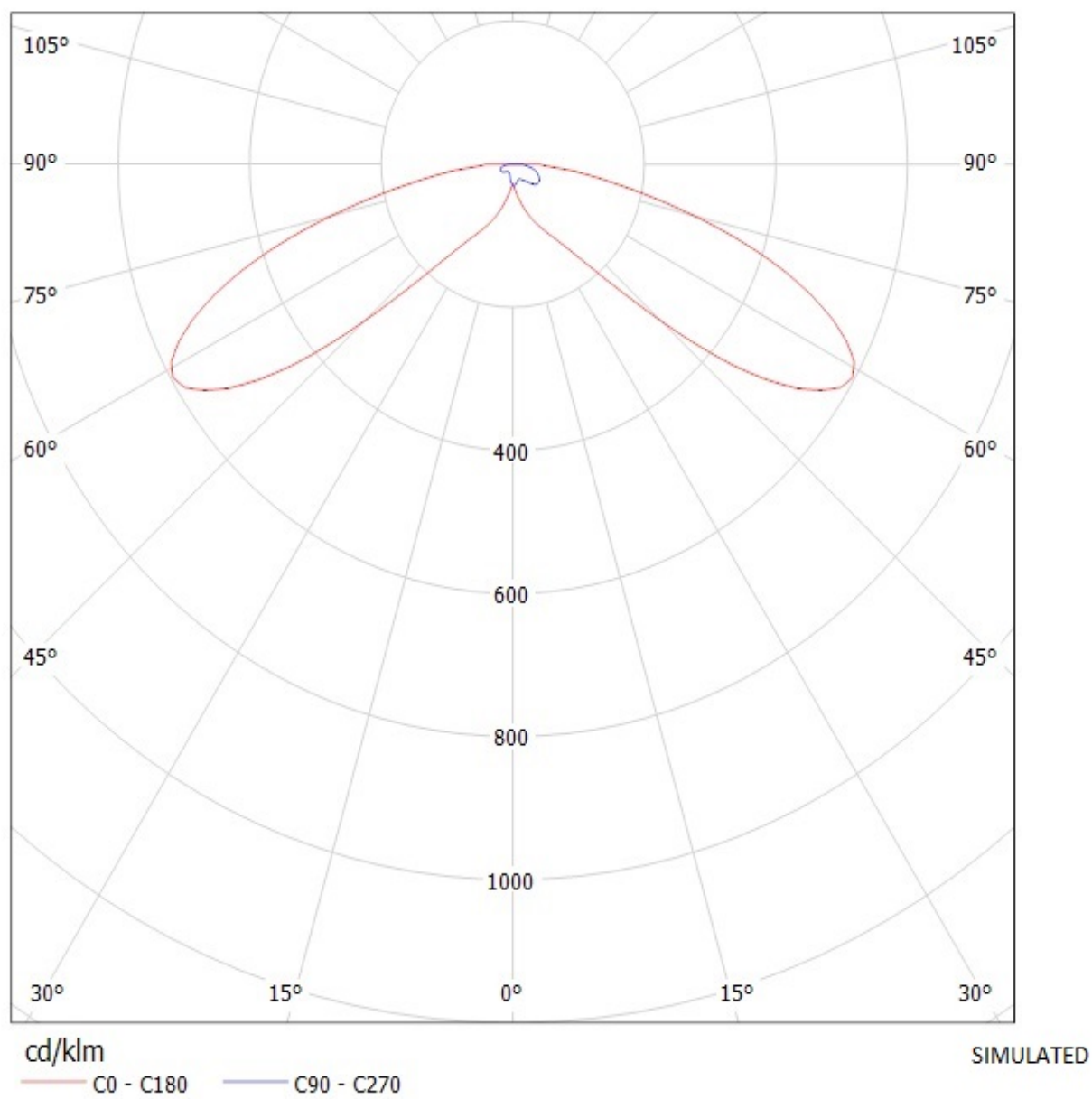

**NOTE: The typical divergence will be changed by different color, chip size and chip position tolerance. The typical total divergence is the full angle measured where the luminous intensity is half of the peak value.**