

## DETAILS

<b>Product Number</b>	C13870_VANESSA-B-W
<b>Family</b>	Vanessa
<b>Type</b>	Lens
<b>Color</b>	clear
<b>Diameter</b>	mm
<b>Height</b>	8 mm
<b>Style</b>	rectang
<b>Optic Material</b>	PMMA
<b>Holder Material</b>	
<b>Fastening</b>	
<b>Status</b>	ready
<b>ROHS Compliant</b>	Yes
<b>Date Updated</b>	9/05/2014



## OPTICAL PROPERTIES

LED	Viewing Angle	Light Beam	Efficiency	cd/lm	connector
XT-E	35 degrees		92 %	1.780	-
LUXEON Rebel ES	36 degrees		93 %	1.730	-
XP-E	38 degrees		92 %	1.730	-
XP-G2	39 degrees		92 %	1.600	-
XP-G	40 degrees		90 %	1.500	-

H G F E D C B A

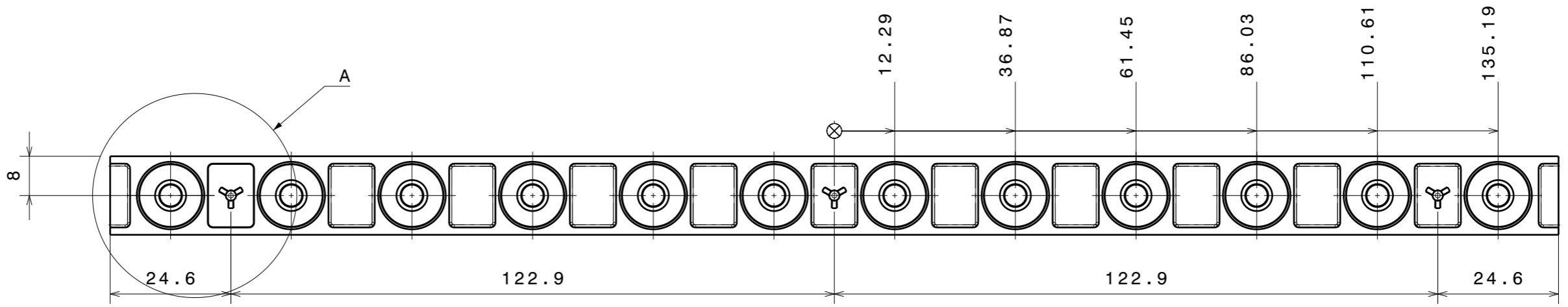

Isometric view  
Scale: 1:2

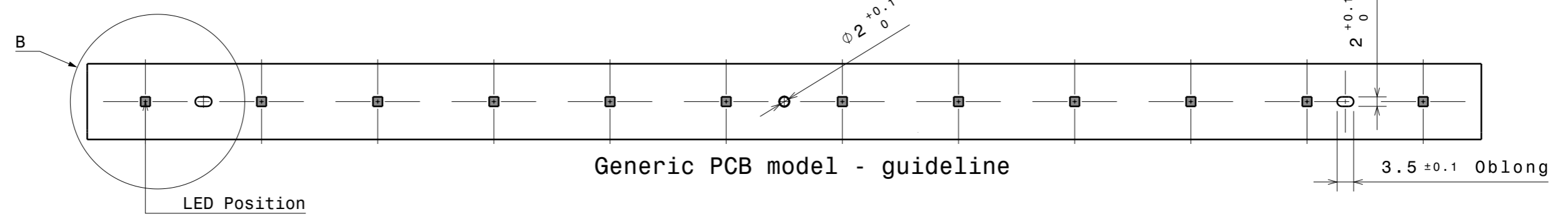
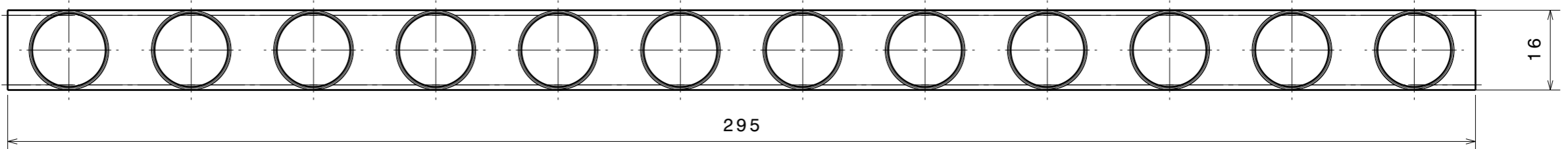
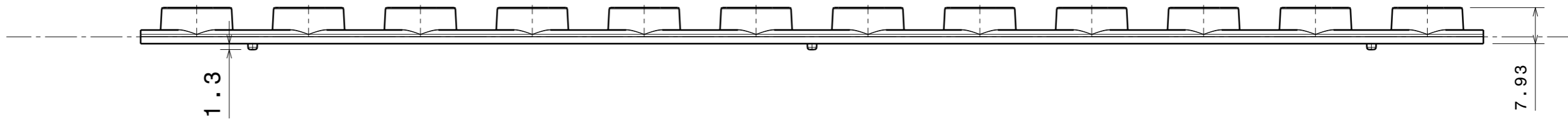
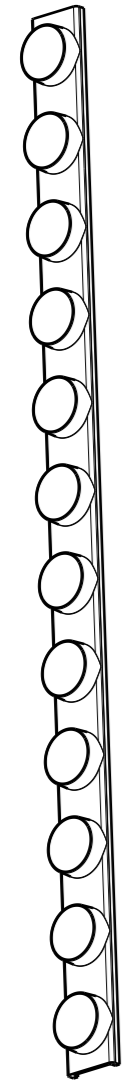

Generic PCB model - guideline

LED Position

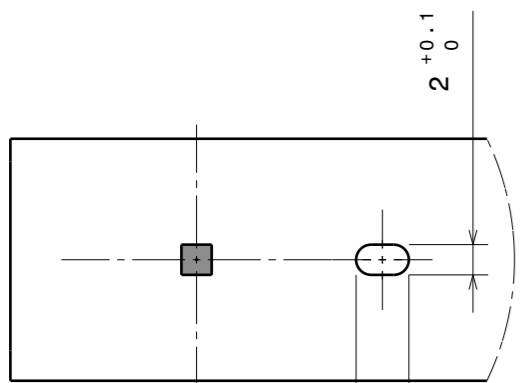

Detail B  
Scale: 2:1

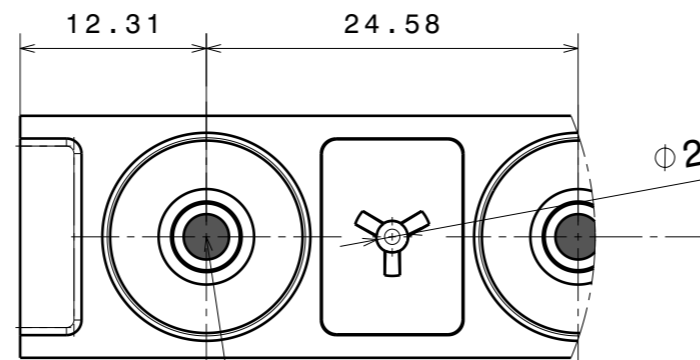

Detail A  
Scale: 2:1

LED position

Tolerances if not otherwise shown  
Linear measures: class M  
according to DIN ISO 2768-1  
Form and position: class K  
according to DIN ISO 2768-2

THIRD ANGLE PROJECTION:

This drawing is the property of LEDiL Oy. It may not be reproduced, copied or communicated without a written agreement with LEDiL Oy."

INDEX	PART NO	DESCRIPTION	MATERIAL	COLOUR
1	Datasheet	VANESSA	PMMA	Clear

**LEDiL** LediL Oy  
Salorankatu 10  
FIN 24240 SALO  
Finland

DRAWING TITLE  
**Datasheet\_VANESSA**

SIZE	PART NUMBER
<b>A3</b>	-

SCALE	1:1	WEIGHT	(g)	SHEET	1/1
-------	-----	--------	-----	-------	-----

H G B A

Luminaire: LEDiL Oy C13870\_VANESSA-B-W\_(XT-E)  
Lamps: 1 x CREE\_XT-E\_12x1\_1556lm@250mA\_P=8.48621W\_I=249.8mA

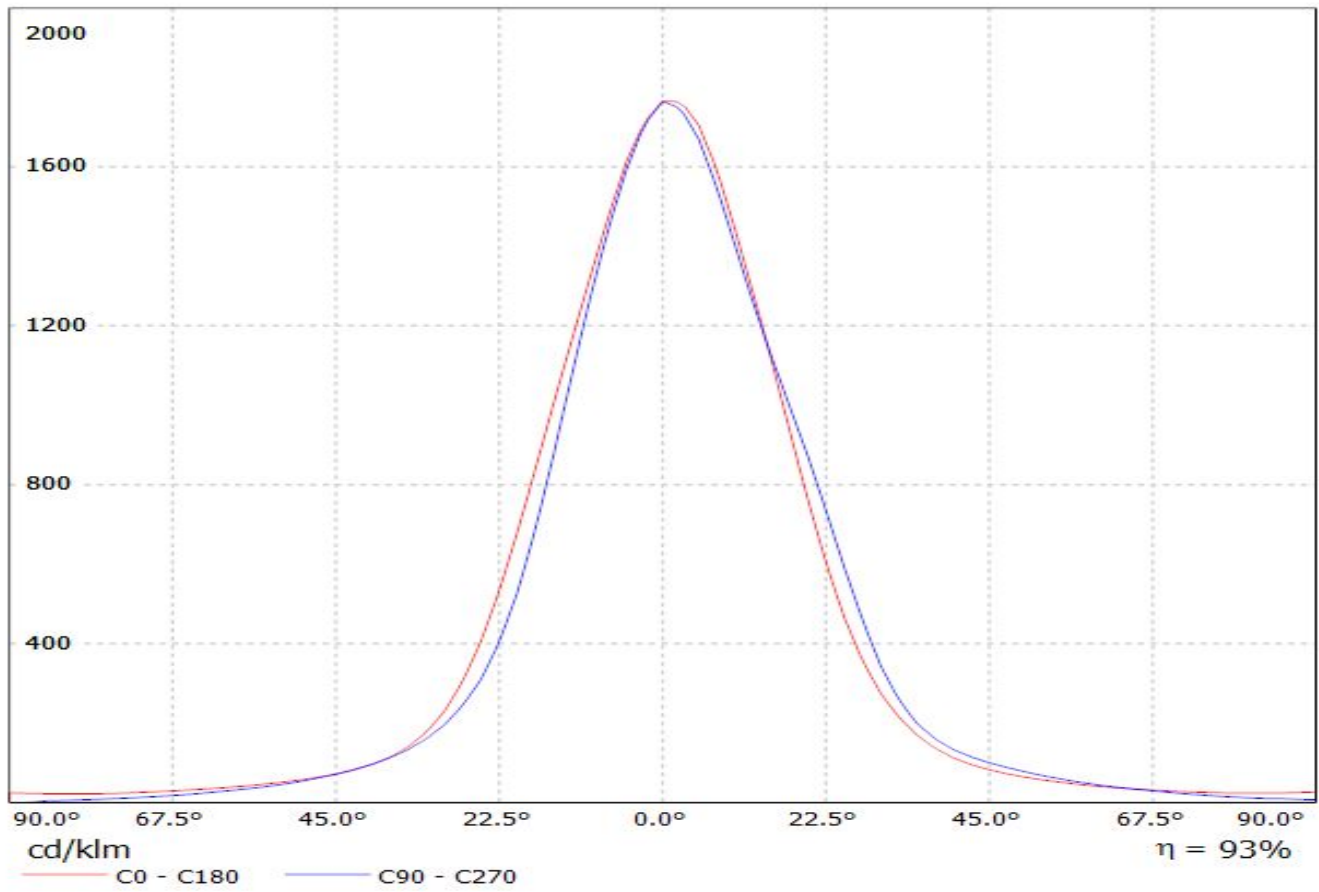

Luminaire: LEDiL Oy C13870\_VANESSA-B-W\_(REBEL-ES)  
Lamps: 1 x REBEL-ES\_12x1\_811@250mA\_P=9.07798W\_I=249.8mA

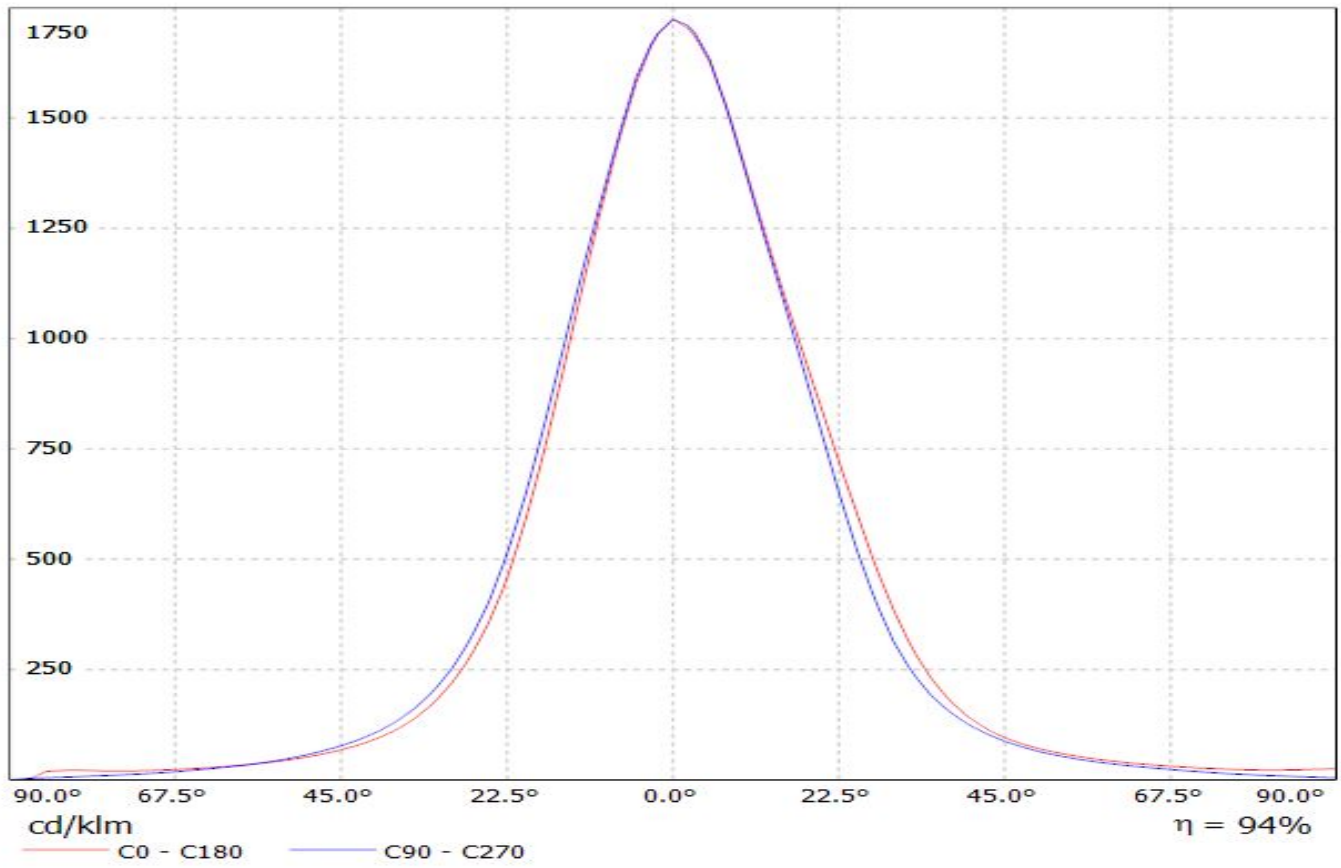

Luminaire: LEDiL Oy C13870\_VANESSA-B-W\_(XP-E)  
Lamps: 1 x CREE\_XP-E\_12x1 910lm@250mA

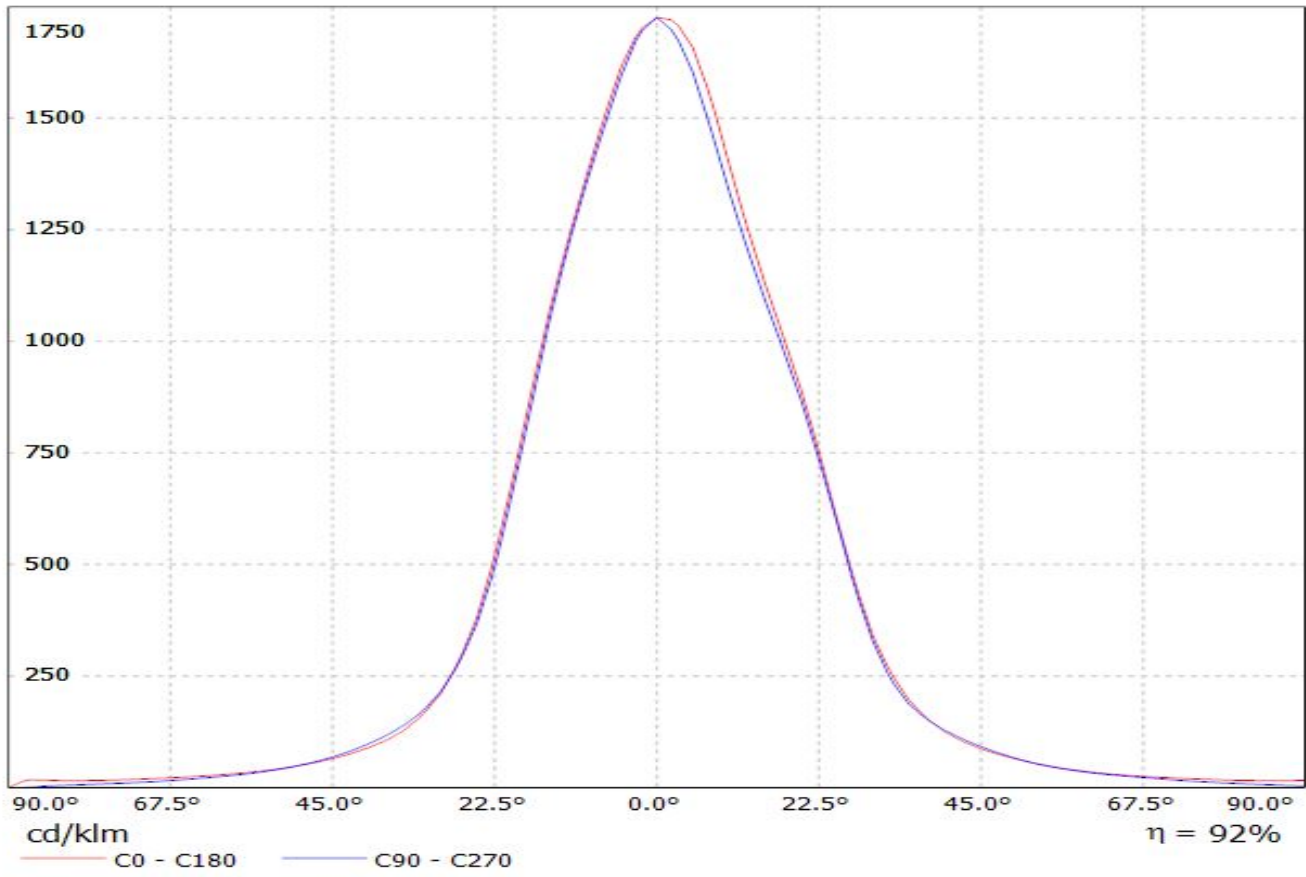

Luminaire: LEDiL Oy C13870\_VANESSA-B-W\_(XP-G2)  
Lamps: 1 x CREE\_XP-G2\_12x1\_1174.06@250mA\_P=8.65107\_I=249.8mA

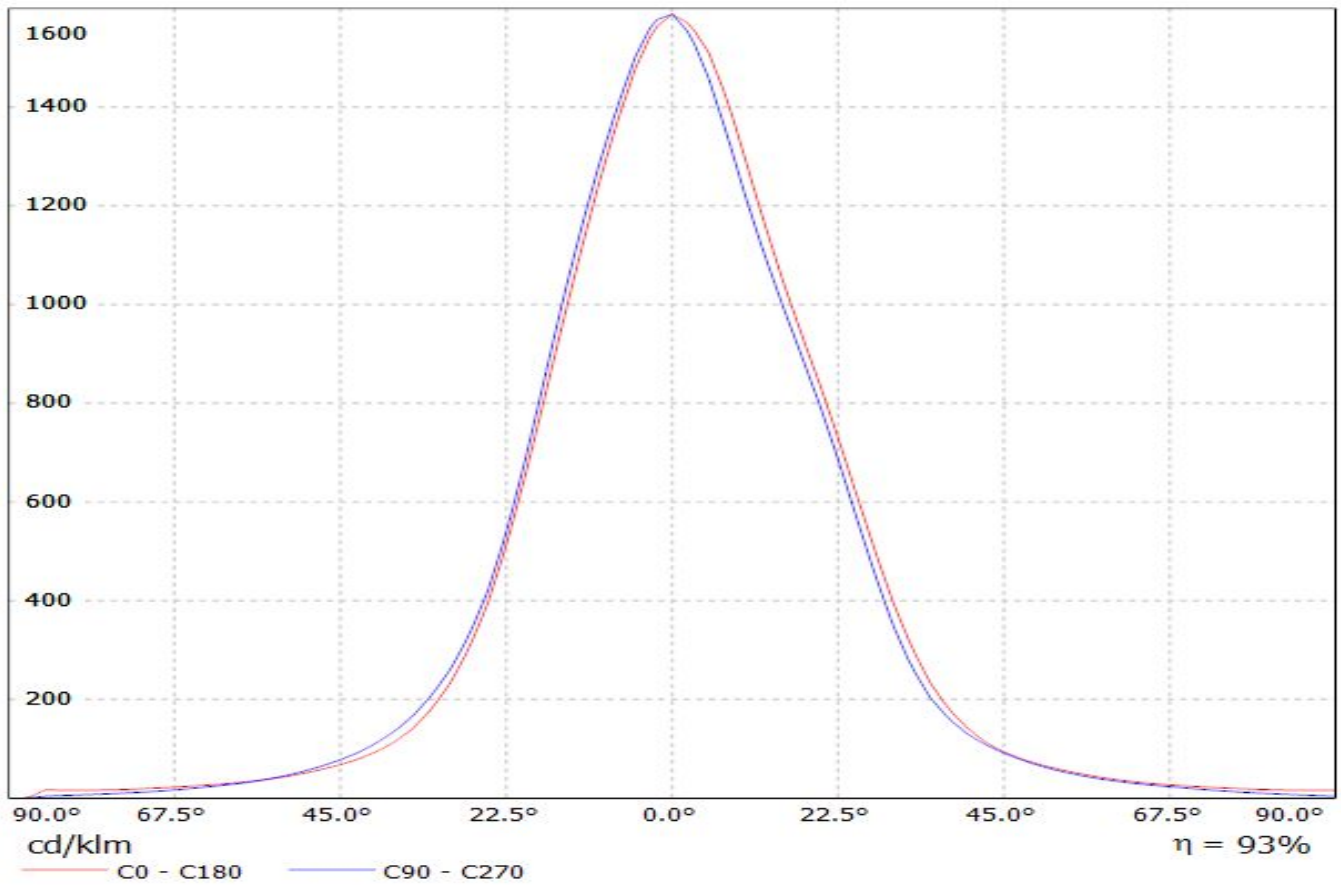

Luminaire: LEDiL Oy C13870\_VANESSA-B-W\_(XP-G)

Lamps: 1 x CREE\_XP-G\_(XPGWHT-L1-4C0-R5-0-09)\_1113.14lm@250mA\_P=8.48621W\_I=249.8mA

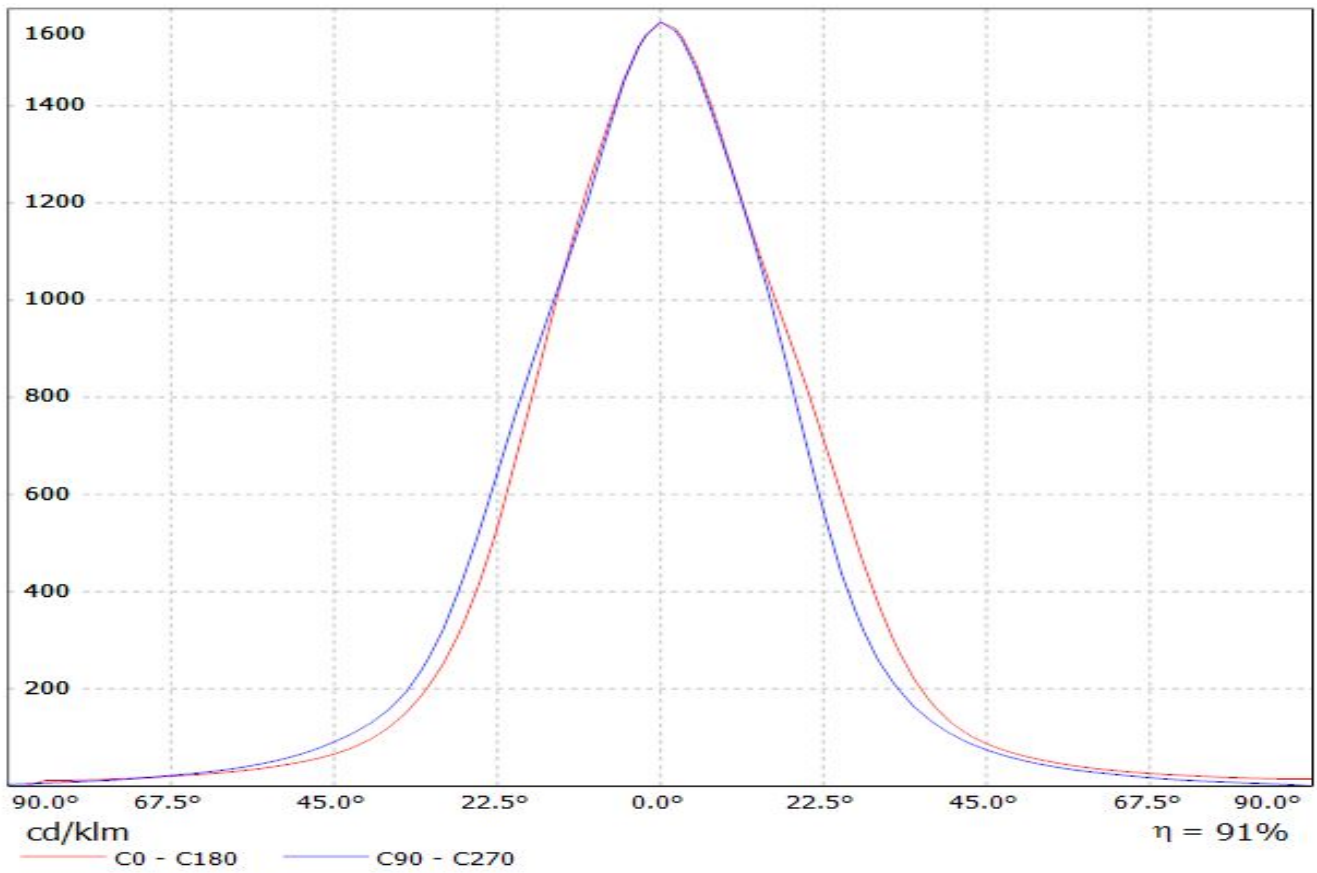

Luminaire: LEDiL Oy C13870\_VANESSA-B-W\_(XT-E)

Lamps: 1 x CREE\_XT-E\_12x1\_1556lm@250mA\_P=8.48621W\_I=249.8mA

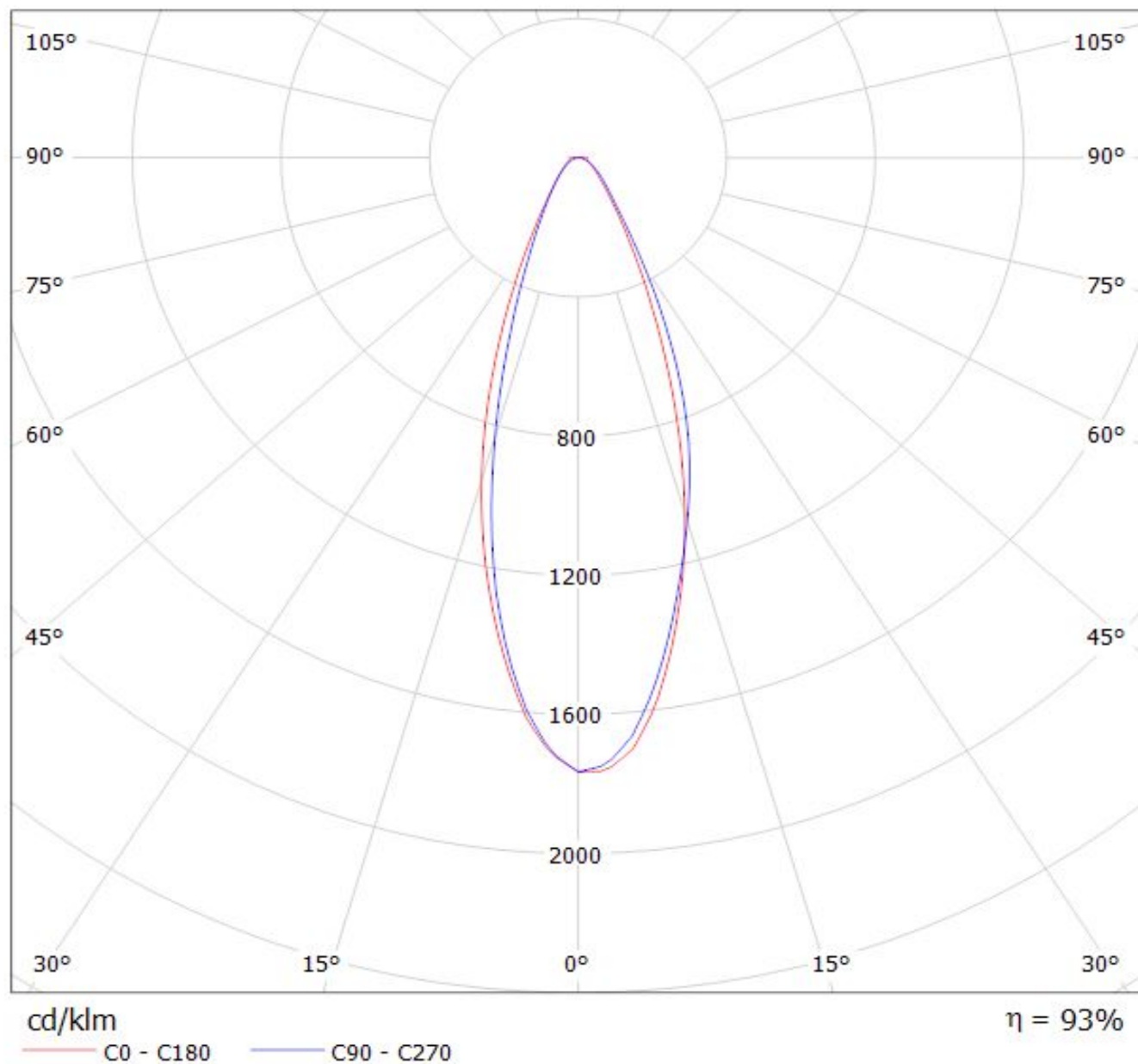



Luminaire: LEDiL Oy C13870\_VANESSA-B-W\_(REBEL-ES)  
Lamps: 1 x REBEL-ES\_12x1\_811@250mA\_P=9.07798W\_I=249.8mA

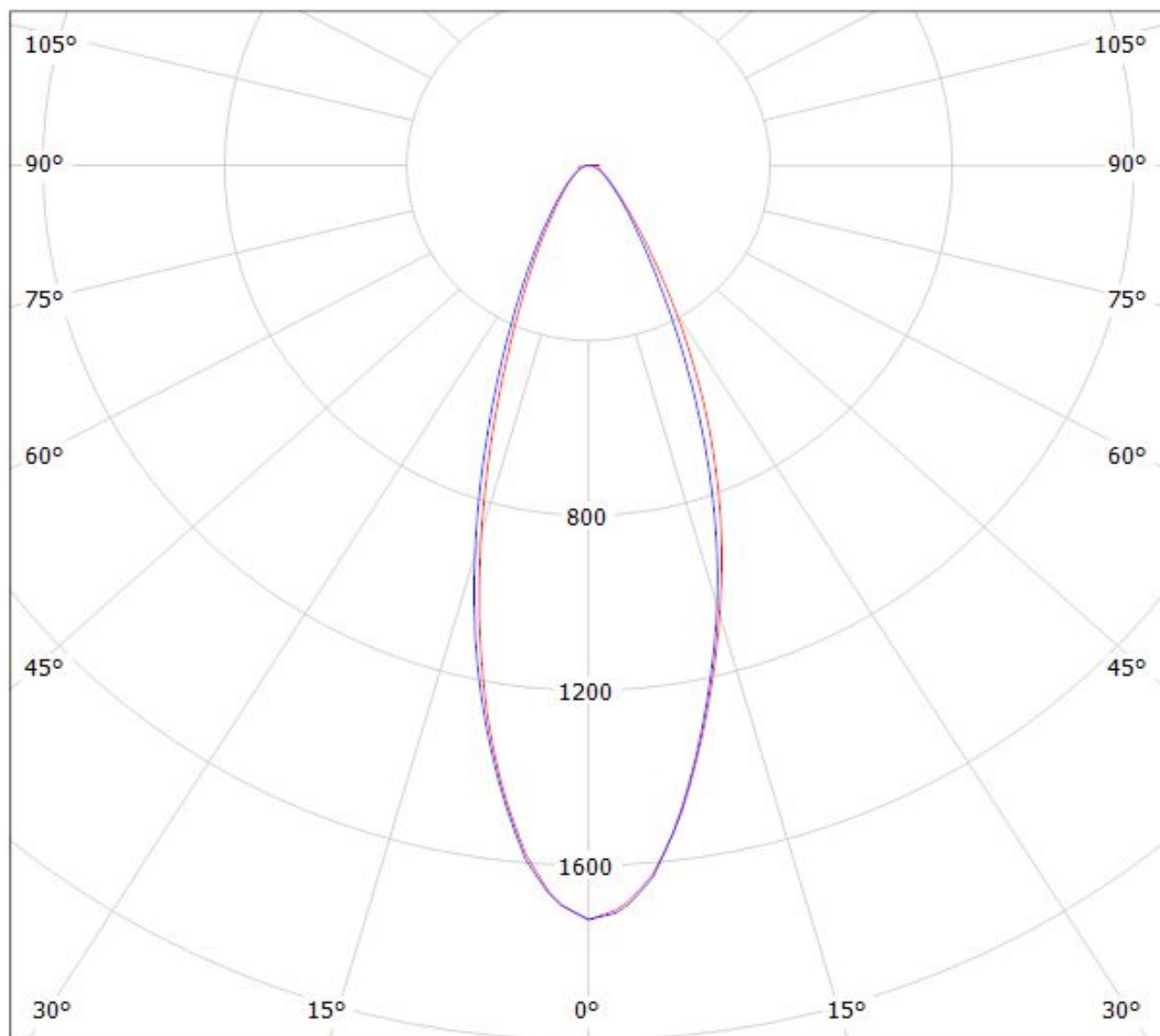

cd/klm

— C0 - C180

— C90 - C270

$\eta = 94\%$

Luminaire: LEDiL Oy C13870\_VANESSA-B-W\_(XP-E)  
Lamps: 1 x CREE\_XP-E\_12x1 910lm@250mA

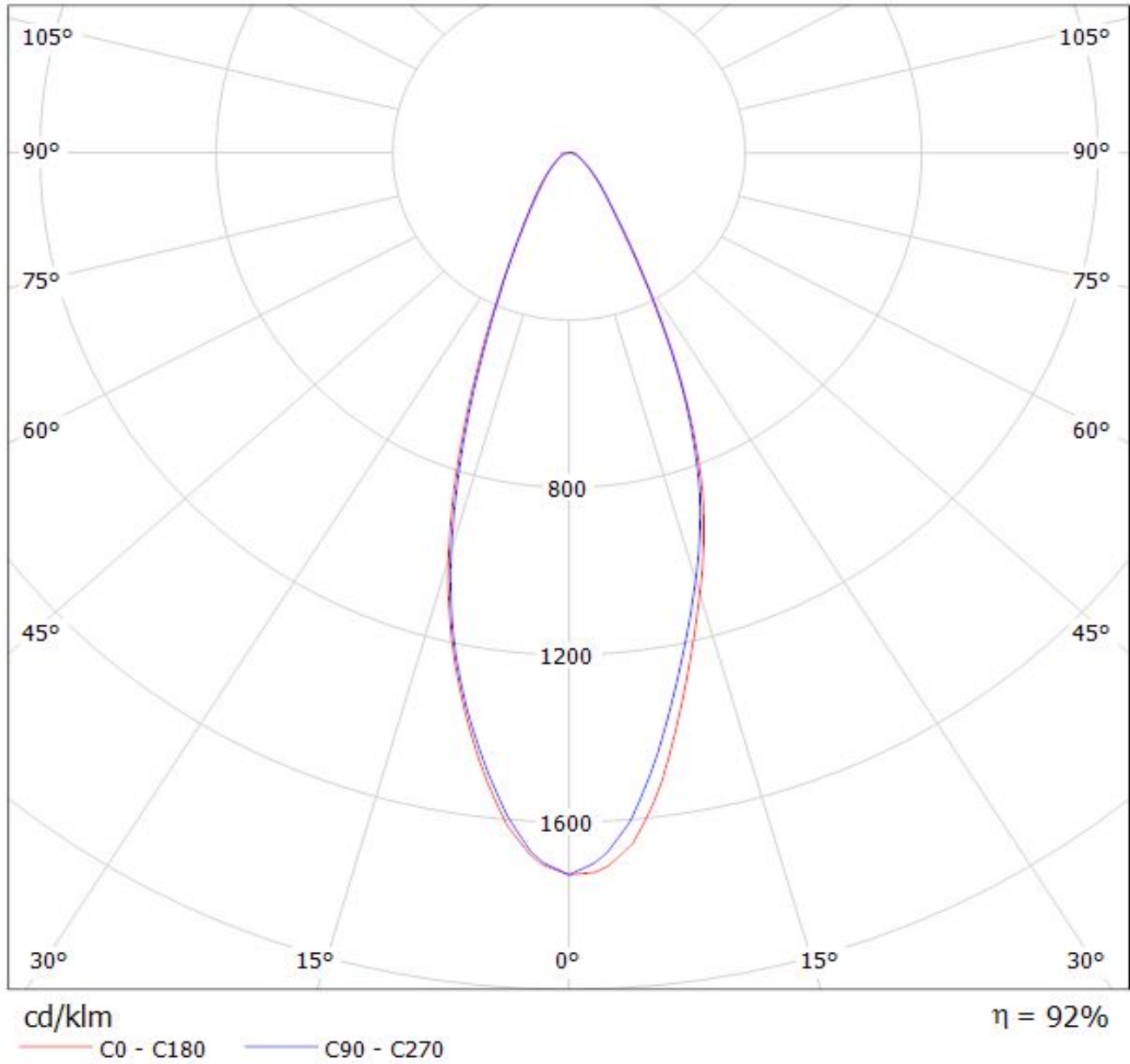

Luminaire: LEDiL Oy C13870\_VANESSA-B-W\_(XP-G2)

Lamps: 1 x CREE\_XP-G2\_12x1\_1174.06@250mA\_P=8.65107\_I=249.8mA

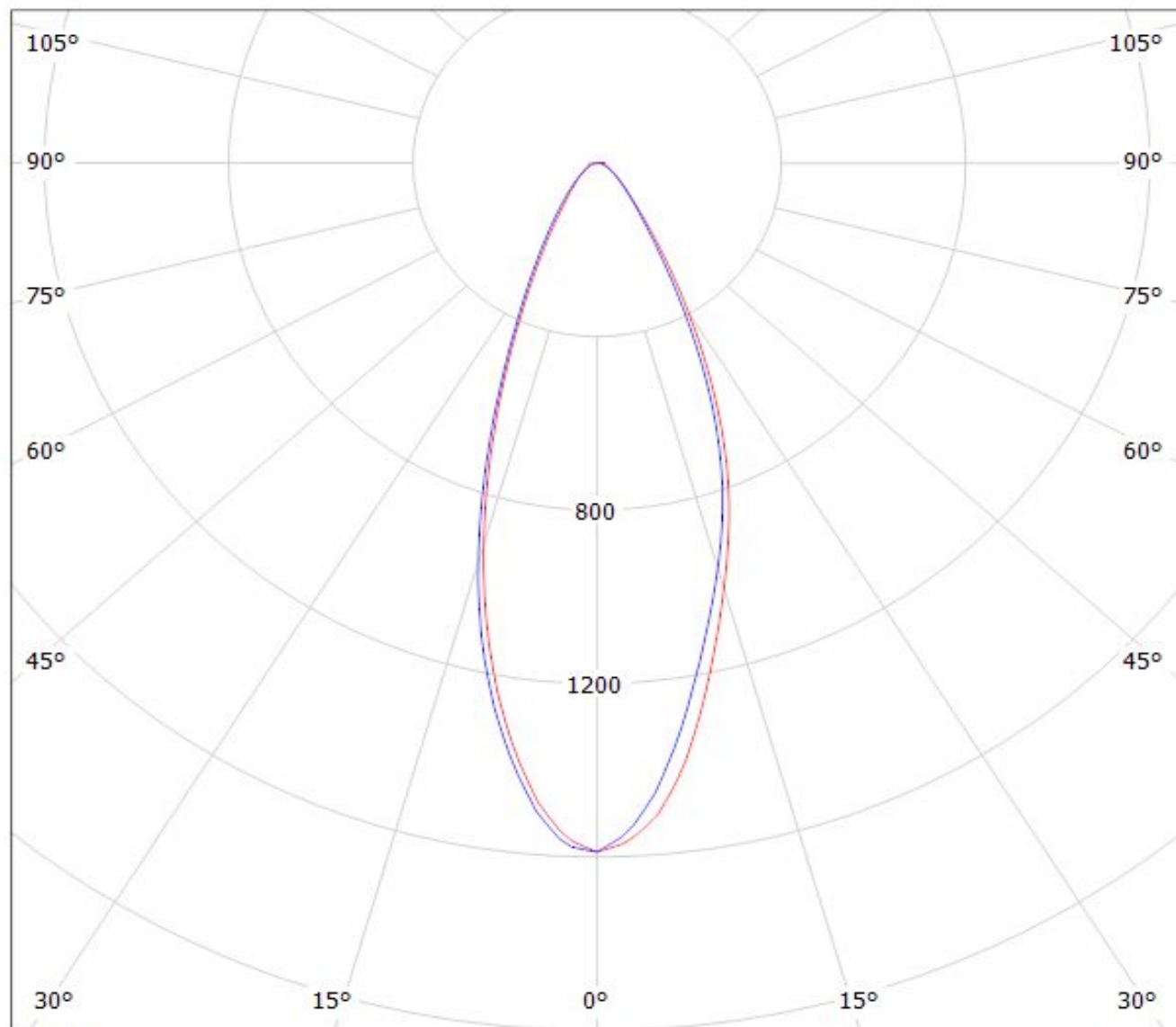

cd/klm

— C0 - C180

— C90 - C270

$\eta = 93\%$

Luminaire: LEDiL Oy C13870\_VANESSA-B-W\_(XP-G)

Lamps: 1 x CREE\_XP-G\_(XPGWHT-L1-4C0-R5-0-09)\_1113.14lm@250mA\_P=8.48621W\_I=249.8mA

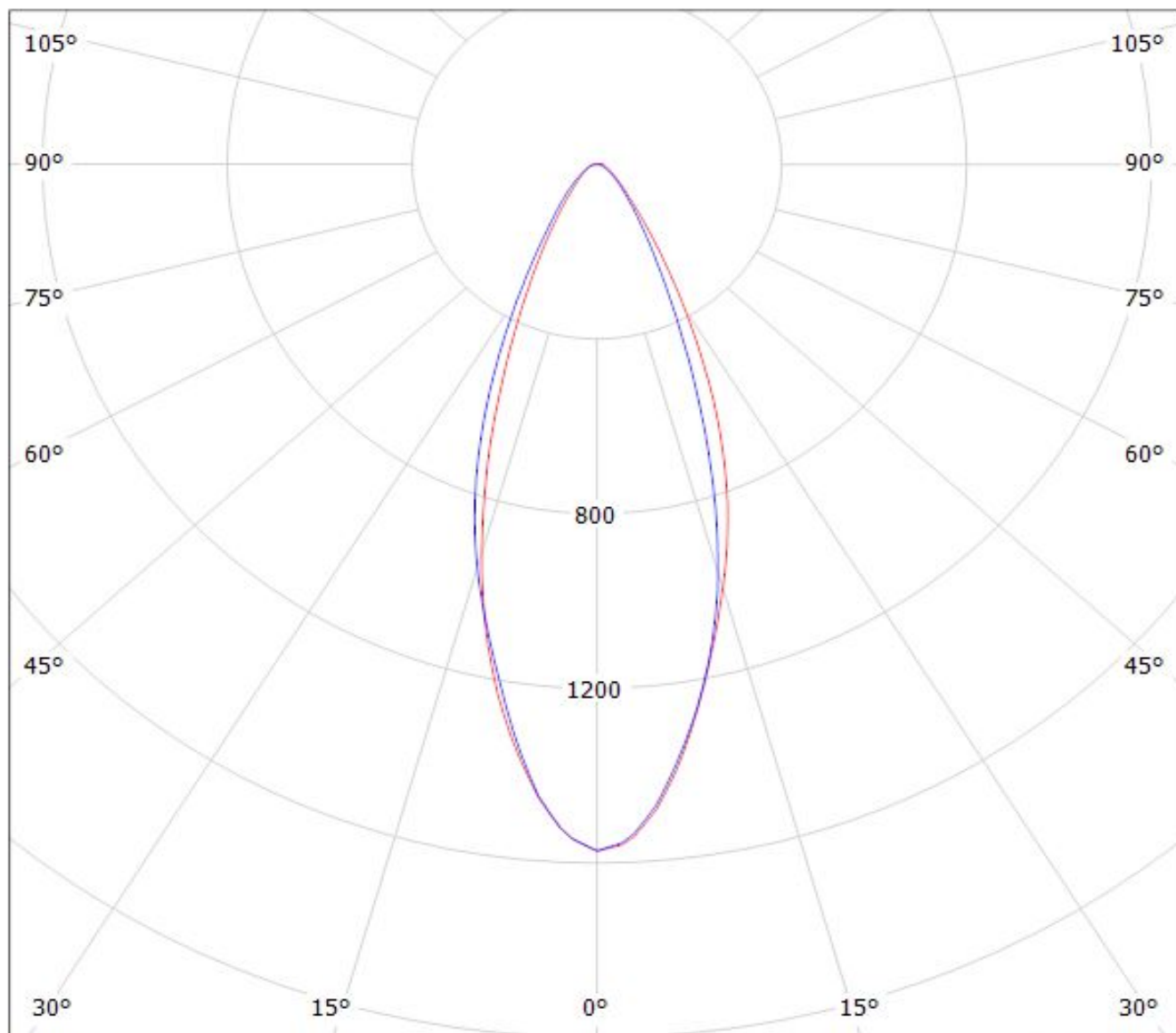

cd/klm

— C0 - C180

— C90 - C270

$\eta = 91\%$

**NOTE: The typical divergence will be changed by different color, chip size and chip position tolerance. The typical total divergence is the full angle measured where the luminous intensity is half of the peak value.**