

Product Specification

Product class: LED LENS

Item No: **DK-100-160X40-TP-II-long-28H1**

Material: PC (UV)

Certification: RoHS

Content

Specification-----	3
2D Drawing-----	4
Optical Datasheet-----	5
Packing Details-----	6
Application Notes-----	7

Specification

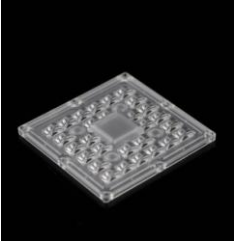
Item No	Picture	Size	Matched LED	Lighting Application
DK-100-160X40-TP-II-long-28H1		Diameter: 100*100mm Height: 9.5mm FWHM: 160X40°	3535	street lamp

Drawing

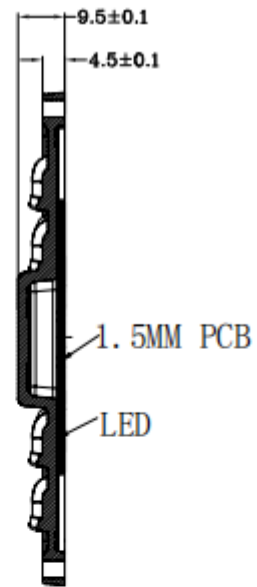
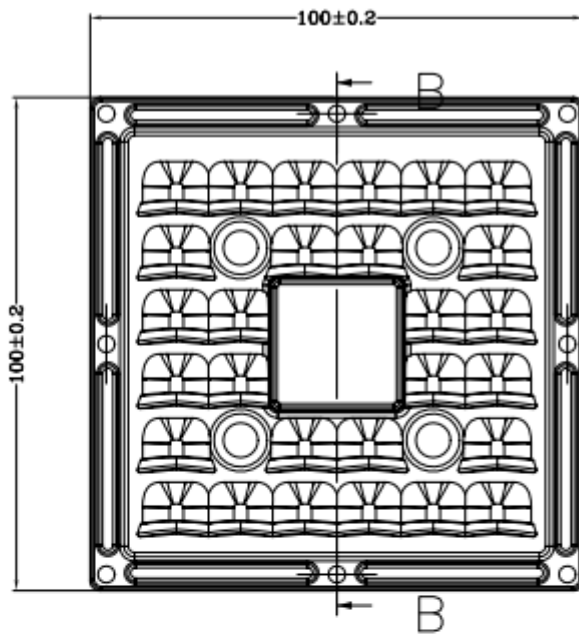

SECTION B-B

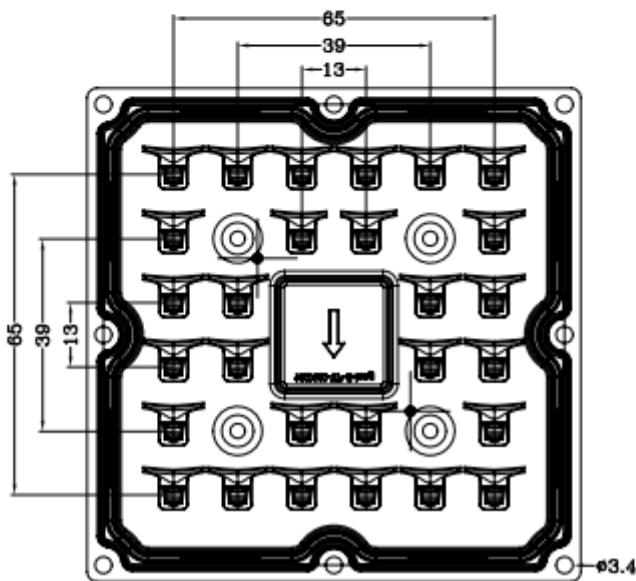

Optical test report

产品特点

灯具制造厂商:
电压: 38.0 V
功率: 4.42 W

电流: 0.116 A
功率因数: 1.000

光度结果

灯具CIE分类: 直接型
灯具光通量: 579.4 lm
下射光通量比: 100%

额定光通量: 579.4 lm
灯具效率: 100%
上射光通量比: 0%

水平扩散角(25%, 50%, 75%, 100%): H166.3, H156.4, H145.3, H120

垂直扩散角(25%, 50%, 75%, 100%): V130.3, V64.2, V39.9, V16

灯具光效等级(LER): 131.13

中心光强: 115.74 cd

峰值光强: 205.37 cd

峰值光强位置: H180 V70

S/MH(C0/C180): 2.06

S/MH(C90/C270): 1.20

灯具实物照片



配光曲线

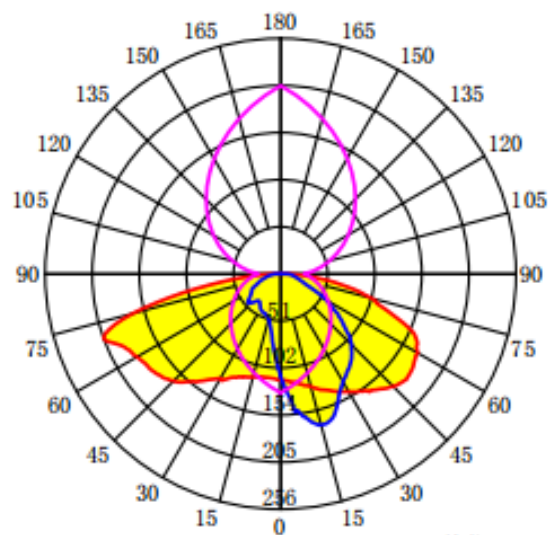

平均光束角(50%): 105.5°

— C0-C180 — C90-C270 — G70

配光曲线

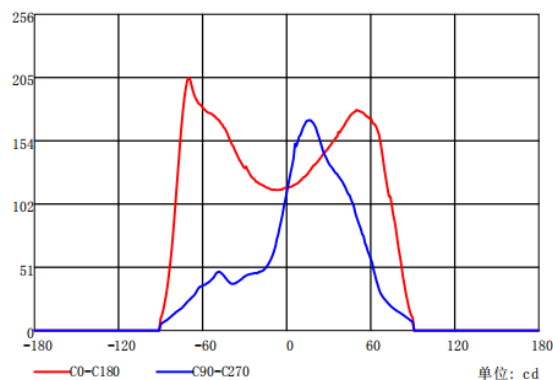
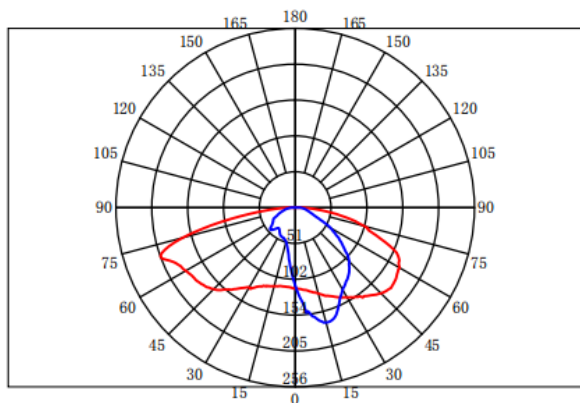

Packing Details

Packing Material	Packing Materil size	Packing Specification
Pearl wool	310*230mm	xxPCS/inner box 4inner box / 1 outer box
White paperboard	A level; 400g; 310*235mm	
Inner box	335*245*105mm	
Outer box	A=B 510*330*255mm	

Application Notes

(1) Please use a little water and soft fabric (air-laid paper) to clean the lens & reflector if necessary.

(2) Forbid to use industrial solvent to clean the lens, such as alcohol.

(3) The working temperature is $-40^{\circ}\text{C}\sim+80^{\circ}\text{C}$ (PMMA) or $-35^{\circ}\text{C}\sim+120^{\circ}\text{C}$ (PC).

(4) Storage environment temperature is $0^{\circ}\text{C}\sim40^{\circ}\text{C}$, humidity is 30%~95%。

Optic Lens has the function to change the ray of light, it is made of optical material, the effect shall be influenced once pollute. Please do not open the packing before use it, to avoid the dust pollution.

(5) Protect the product from the sun and other ultraviolet ray, as these will lead to aging, change color, crack, etc.

(6) Please wear gloves once install the lens, avoid to abrasion the lens surface.

(7) Forbid to use acidic or alkaline solution touch the product, avoid to generate the chemical reactions.