

SPECIFICATION
MODEL : SPHWWTHDNA45YHVTJC



[Approved Rank : V_F(YH), CIE(VB, VC, VD, VE, VF, VG, VH), Lm(JB, MA)]

HD36J

CUSTOMER :		
DRAWN	CHECKED	APPROVED

SAMSUNG ELECTRONICS		
DRAWN	CHECKED	APPROVED

SAMSUNG ELECTRONICS
95, SAMSUNG 2-RO, GIHEUNG-GU,
YONGIN-CITY, GYEONGGI-DO, 446-711, KOREA

Contents

1. Product Outline	-----	3
2. Absolute Maximum Rating	-----	3
3. Characteristics	-----	3
4. Typical Characteristics Graph	-----	6
5. Outline Drawing & Dimension	-----	8
6. Reliability Test Items and Conditions	-----	9
7. Label Structure	-----	10
8. Lot Number	-----	11
9. Tray Dimension	-----	12
10. Aluminum Bag Dimension	-----	12
11. Box & Pad Dimension	-----	13
12. Packing Structure	-----	14
13. Precaution for use	-----	16
14. Revision History	-----	17

1. Product Outline

1) Features

- 13W HVDC LED : 25.25 x 20.25 x t 1.5 (mm)
- InGaN/GaN MQW LED with long-time reliability
- Lead (Pd) free product - RoHS compliant

2) Applications

- Spot / Downlighting
- LED Retrofit Bulbs
- Outdoor illumination
- Other applications

2. Absolute Maximum Rating

- 1) Operation Forward Current ($T_a = 25^\circ\text{C}$) 450 mA
- 2) Flash Mode Peak Pulsed Forward Current 470 mA
(Pulse width $t \leq 10\text{msec}$, Duty ratio=0.06, $T_a=25^\circ\text{C}$)
- 3) Thermal Resistance ($R_{th,j-c}$) 1.5°C/W
- 4) LED Junction Temperature (T_J) 150°C
- 5) Operating Temperature Range (T_{opr}) $-40^\circ\text{C} \sim 85^\circ\text{C}$
- 6) Storage Temperature Range (T_{stg}) $-40^\circ\text{C} \sim 120^\circ\text{C}$

3. Characteristics

1) Electro-Optical characteristics

($T_a : 25^\circ\text{C}$)

Item	Unit	Condition	Rank	Min	Typ	Max
Luminous Flux ²⁾	lm	$I_F = 350 \text{ mA}^{1)}$	JC	950	-	1050
			MA	1050	-	
Forward Voltage (V_F)	$V^{3)}$	$I_F = 350 \text{ mA}$	YH	34	36.5	38.5
CCT	K	$I_F = 350 \text{ mA}$	-	-	3000 ⁴⁾	-
CRI		$I_F = 350 \text{ mA}$	-	80	-	-
View Angle ⁵⁾	°	$I_F = 350 \text{ mA}$	-	-	115°	-

Notes:

- 1) Samsung LED tested in pulsed condition. $T_J=25^\circ\text{C}$, pulse width is 10ms at rated test current.
- 2) Samsung LED has $\pm 10\%$ tolerance of flux measurements.
- 3) Samsung LED has $\pm 5\%$ tolerance of forward voltage measurements.
- 4) Samsung LED has $\pm 5\%$ tolerance of CCT measurements.
- 5) Samsung LED tested in DC=350mA after luminous flux is saturated.
- 6) Samsung LED has $\pm 0.1 \text{ mm}$ tolerance on device dimensions.

2) Electro-Optical characteristics

If (mA)	Vf (V)	Flux (Lm)	Lm/W	CRI
	Typ	Typ	Typ	Min
60	32.45	194	99.51	80
100	33.14	322	97.17	80
150	33.90	477	93.79	80
200	34.58	627	90.60	80
250	35.24	771	87.53	80
300	35.89	913	84.79	80
350	36.50	1050	82.19	80
400	37.16	1184	79.63	80
450	37.74	1313	77.31	80

Note :

1) These values on the table are for reference only.

3) Chromaticity Diagram

(T_a : 25°C)

Table		CIE X	CIE Y
3000K [VT]	VB	0.4451	0.4146
		0.4324	0.4100
		0.4244	0.3922
		0.4361	0.3964
	VC	0.4324	0.4100
		0.4261	0.4077
		0.4185	0.3902
		0.4244	0.3922
	VD	0.4515	0.4168
		0.4451	0.4146
		0.4361	0.3964
		0.4420	0.3985
	VE	0.4431	0.4213
		0.4299	0.4165
		0.4261	0.4077
		0.4388	0.4122

Table		CIE X	CIE Y
3000K [VT]	VF	0.4562	0.4260
		0.4431	0.4213
		0.4388	0.4122
		0.4515	0.4168
	VG	0.4303	0.3944
		0.4185	0.3902
		0.4147	0.3814
		0.4260	0.3854
	VH	0.4420	0.3985
		0.4303	0.3944
		0.4260	0.3854
		0.4373	0.3893

CIE1931 chromaticity diagram(E-Star)

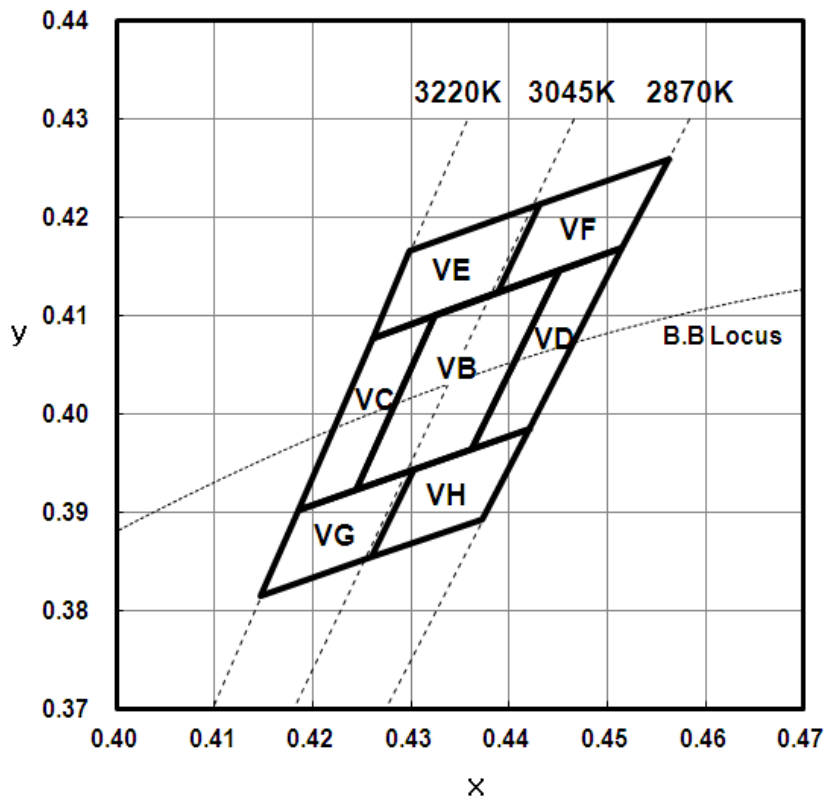

4. Typical Characteristics Graph

* These graphs show typical values.

($T_a : 25^\circ\text{C}$)

Forward Current vs. Relative Luminous Flux

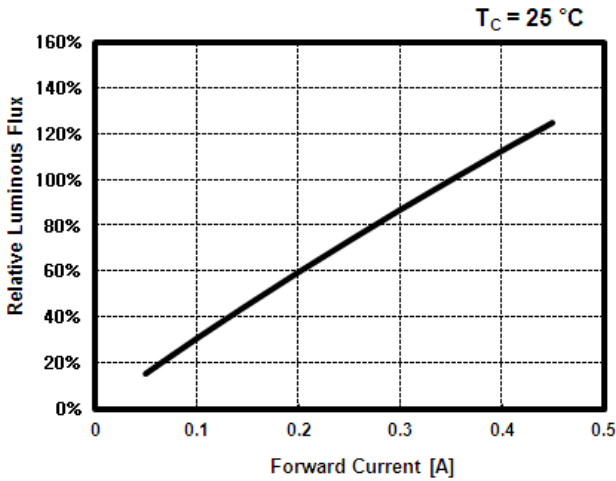

Forward Current vs. Forward Voltage

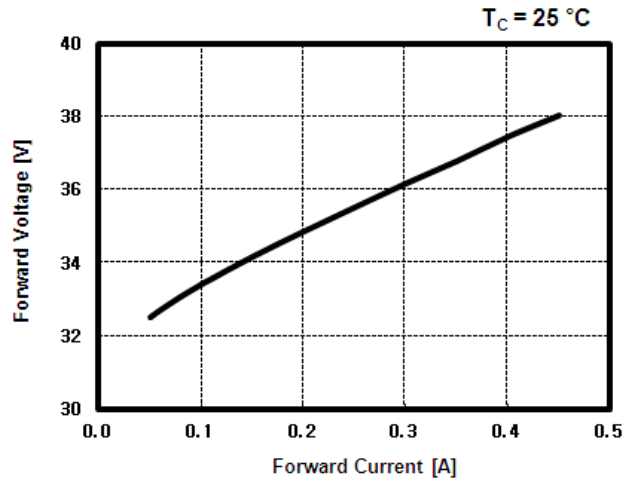

Forward current vs. Chromaticity Coordination

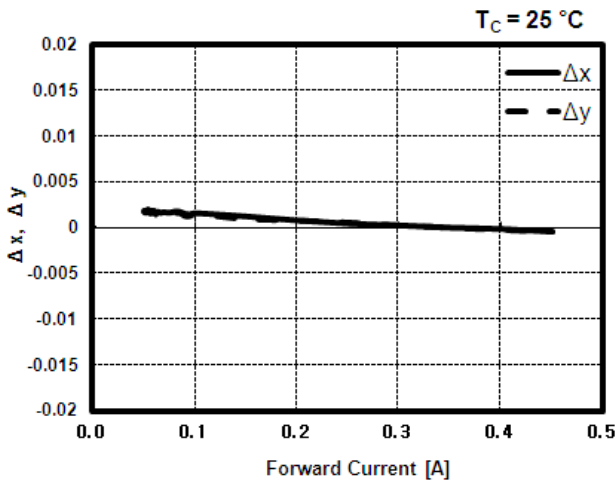

Temperature vs. Chromaticity Coordination

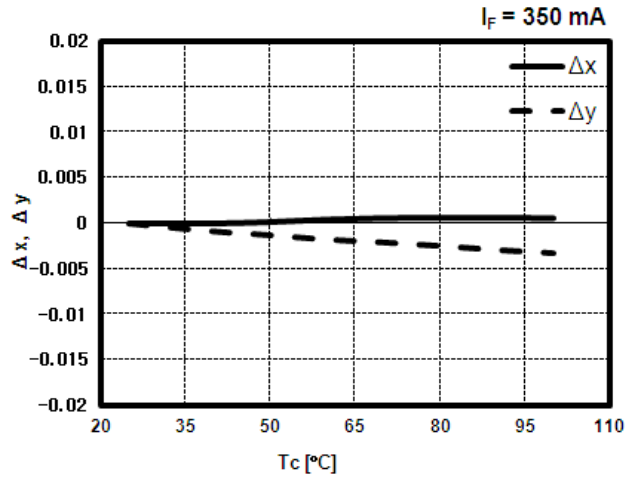

Temperature vs. Voltage

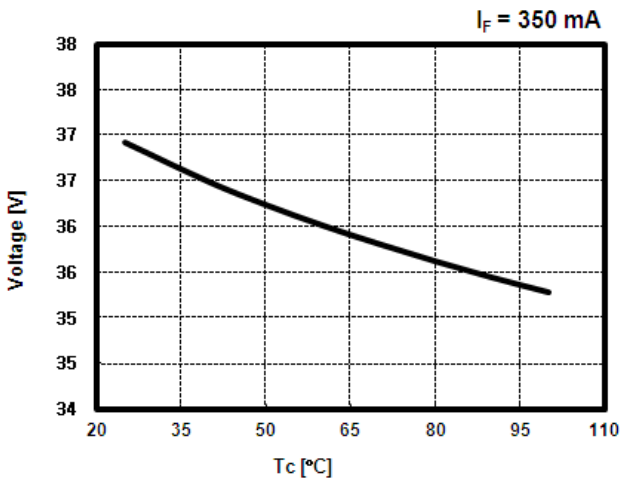

Temperature vs. Relative Luminous Flux

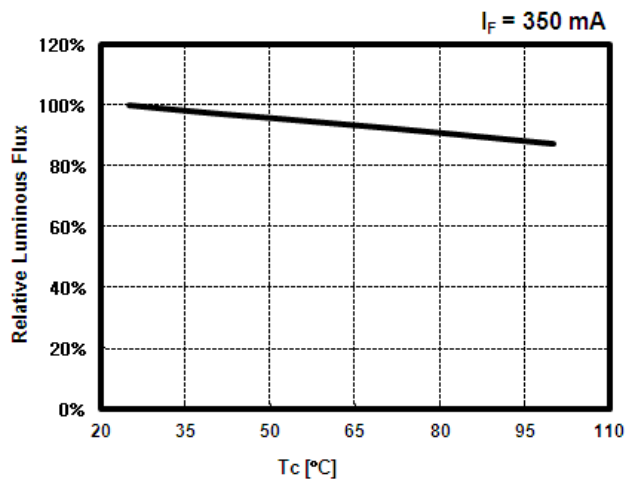

Radiation Pattern

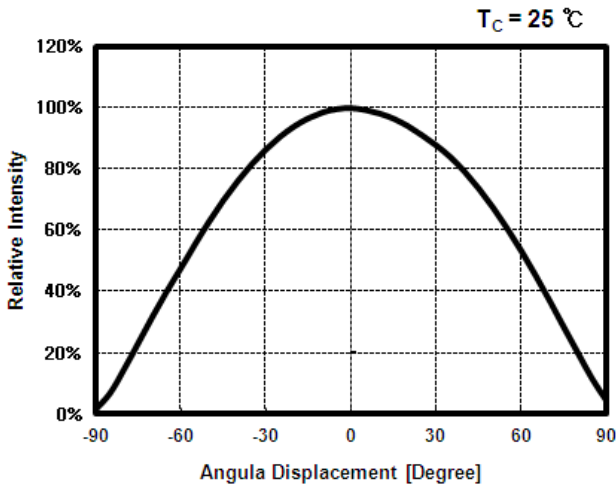

Relative Spectral Emission

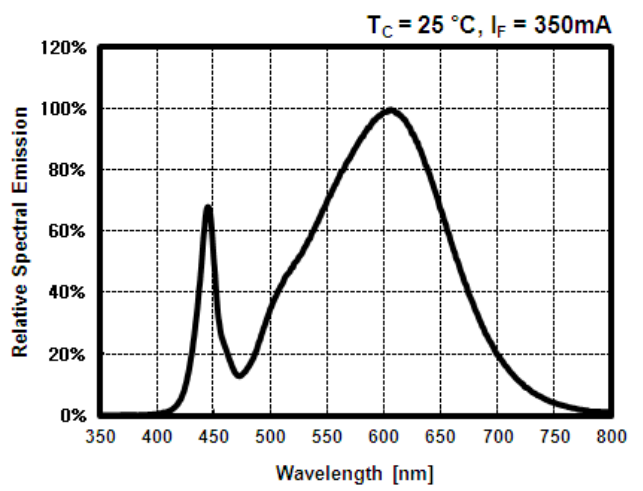

Derating Curve

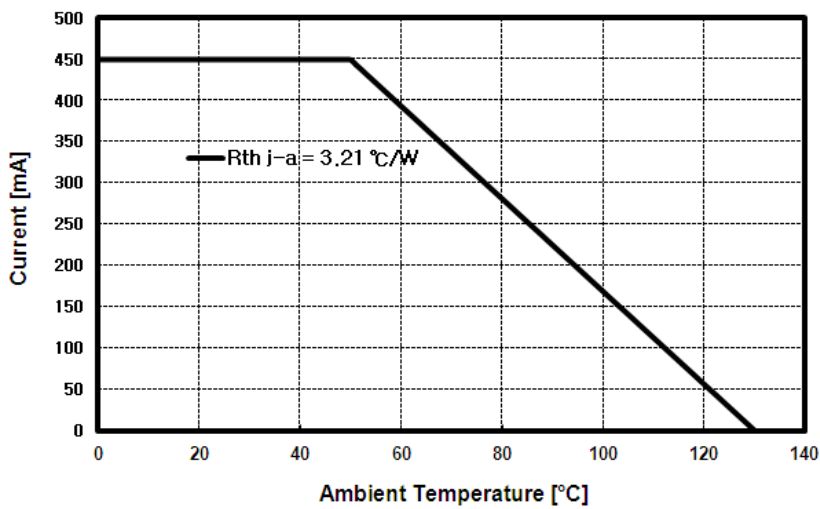

5. Outline Drawing & Dimension

unit : mm
Tolerance : ± 0.1

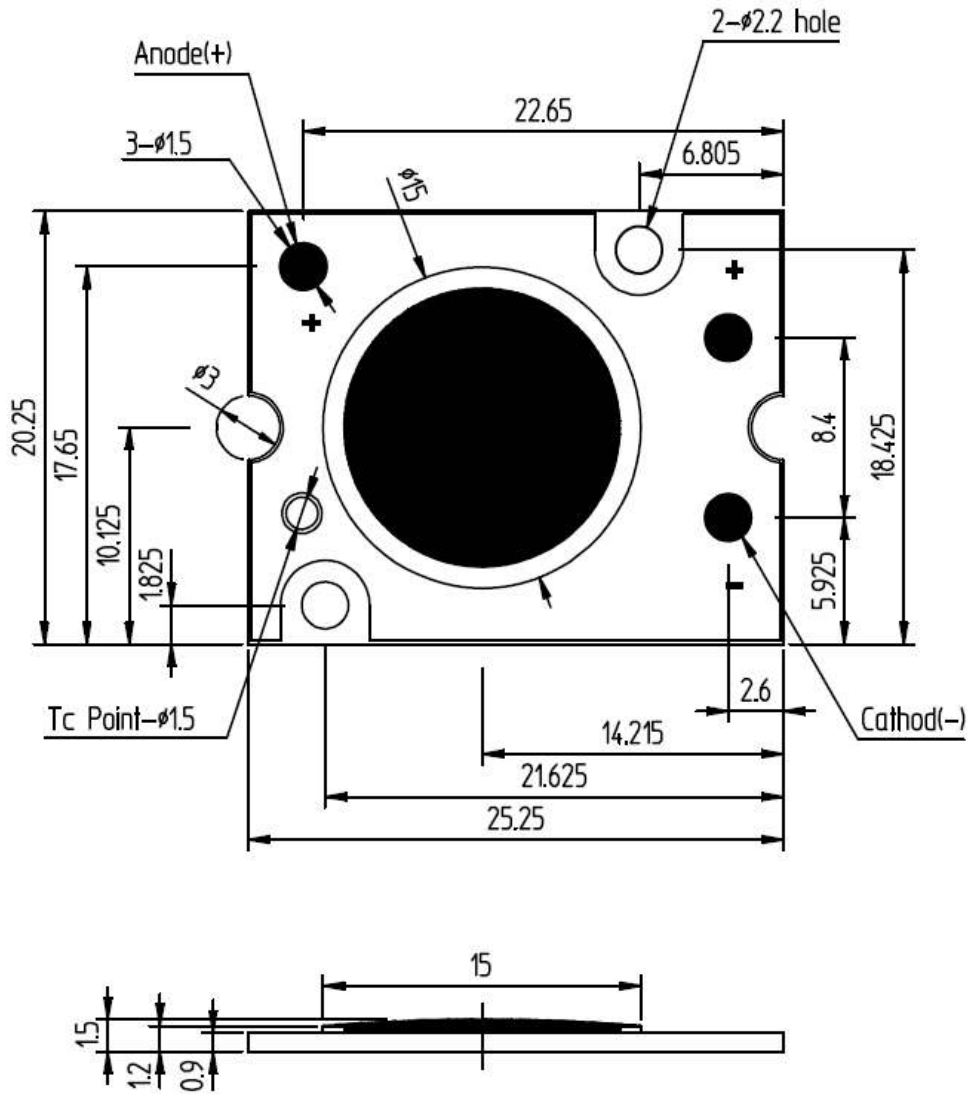

6. Reliability Test Items and Conditions

1) Test Items

Test Items	Test Conditions	Test Hours/Cycles
MSL test	125°C 24h drying → MSL 2a(Sunnix5) 60°C, 60%RH 120h(drying after 2h) → 260°C 10sec 3time(each Cycle) Room Temperature cooling, MSL after 15min during 4 h)	1 time
Room Temperature life test	25°C, I _F = Max	1,000 h
High Temperature humidity life test	85°C, 85% RH, DC Derating I _F = Max	1,000 h
High Temperature life test	85°C, DC Derating I _F = Max	1,000 h
Low Temperature life test	-40°C, DC 450 mA	1,000 h
High Temperature Storage	120°C	1,000 h
Low Temperature Storage	-40°C	1,000 h
Thermal Shock	-45°C/15min → 125°C/15min Temperature changes in 5min.	200 cycles
Temperature Cycle On/Off test	-40 / 85°C, each 20min, 100min transfer Power On/off each 5min, DC 350 mA	100 cycles
Temperature humidity Cycle Storage	-10°C ↔ 25°C, 95%RH ↔ 85°C, 95%RH[24h/1Cycle]	100 cycles
ESD(HBM)	R1 : 10 MΩ, R2 : 1.5 kΩ, C : 100 pF	5 times (± 5 kV)
ESD(MM)	R1 : 10 MΩ, R2 : 0 kΩ, C : 200 pF	5 times (± 0.5 kV)
Vibration	20~80Hz(Displacement:0.06inch, Max 20G) 80~2kHz (Max 20G) Min. Frequency ↔ Max. Frequency 4min transfer	4 times
Shock	1500G, 0.5ms, Every 6faces (3axis X 2faces)	5 times
Salt Spray	35°C, salt water 5% 8h spray → 16h leaving alone	2 cycles

2) Criteria for Failure

Item	Symbol	Test Condition [T _a = 25°C]	Limit	
			Min.	Max.
Forward Voltage	V _F	350 mA	L.S.L. × 0.9	U.S.L. × 1.1
Luminous flux	Im	350 mA	L.S.L. × 0.7	U.S.L. × 1.3

* U.S.L. : Upper Standard Level L.S.L. : Lower Standard Level

7. Label Structure

* Bag & Inner box

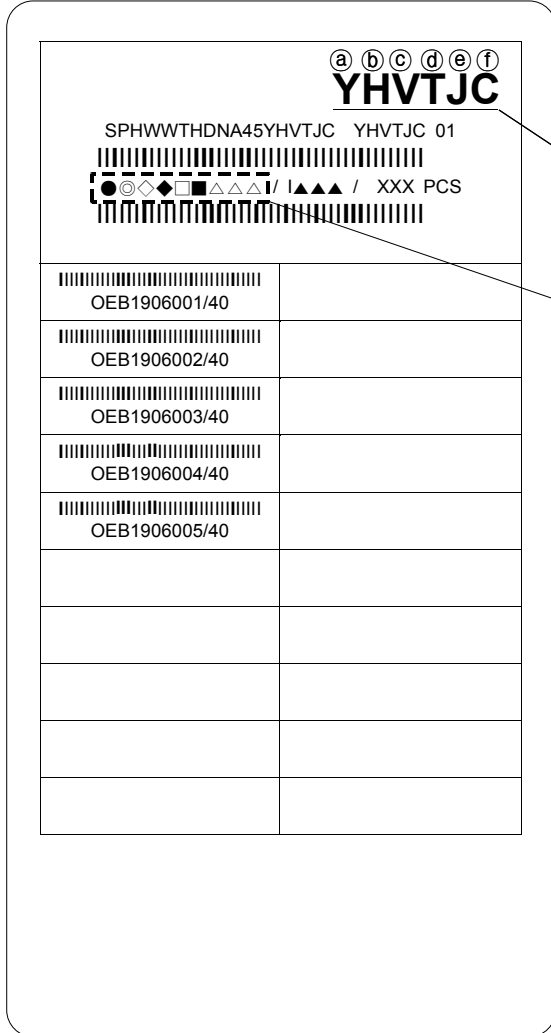

Rank
Code

Lot
number

Tray
number
/Q'ty

* Box

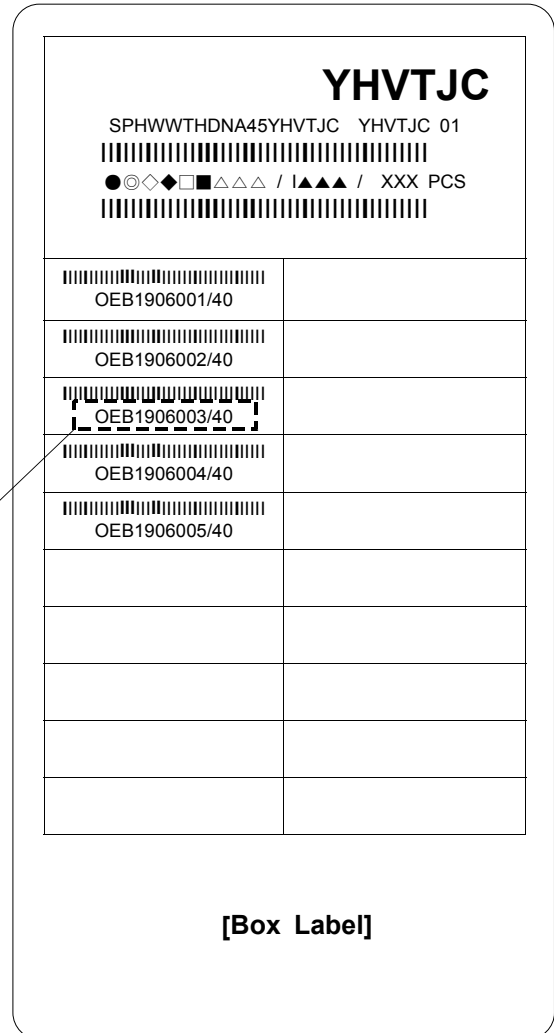

[Box Label]

N.B) Denoted rank is the only example.

Rank Code

- ⒶⒷ : Forward Voltage (V_f) Rank (refer to page. 3)
- ⒸⒹ : Chromaticity Coordinate Rank (refer to page. 5)
- ⒺⒻ : Luminous Flux (Φ_v) Rank (refer to page. 3)

8. Lot Number

The Lot number is composed of the following characters

●◎◇◆□■△△△ / |▲▲▲ / 200PCS

● : Production Site (S:SAMSUNG LED, G:Gosin China, A:Aprosystems)

◎ : L (LED)

◇ : Product State (A:Normality, B: Bulk, C:First Production, R:reproduction, S:Sample)

◆ : Year (S:2008, T:2009, U:2010, V:2011...)

□ : Month (1 ~ 9, A~C)

■ : Day (1 ~ 9, A, B ~ V)

△ : SAMSUNG LED Product number (1 ~ 999)

▲ : Tray Number (1 ~ 999)

9. Tray Dimension

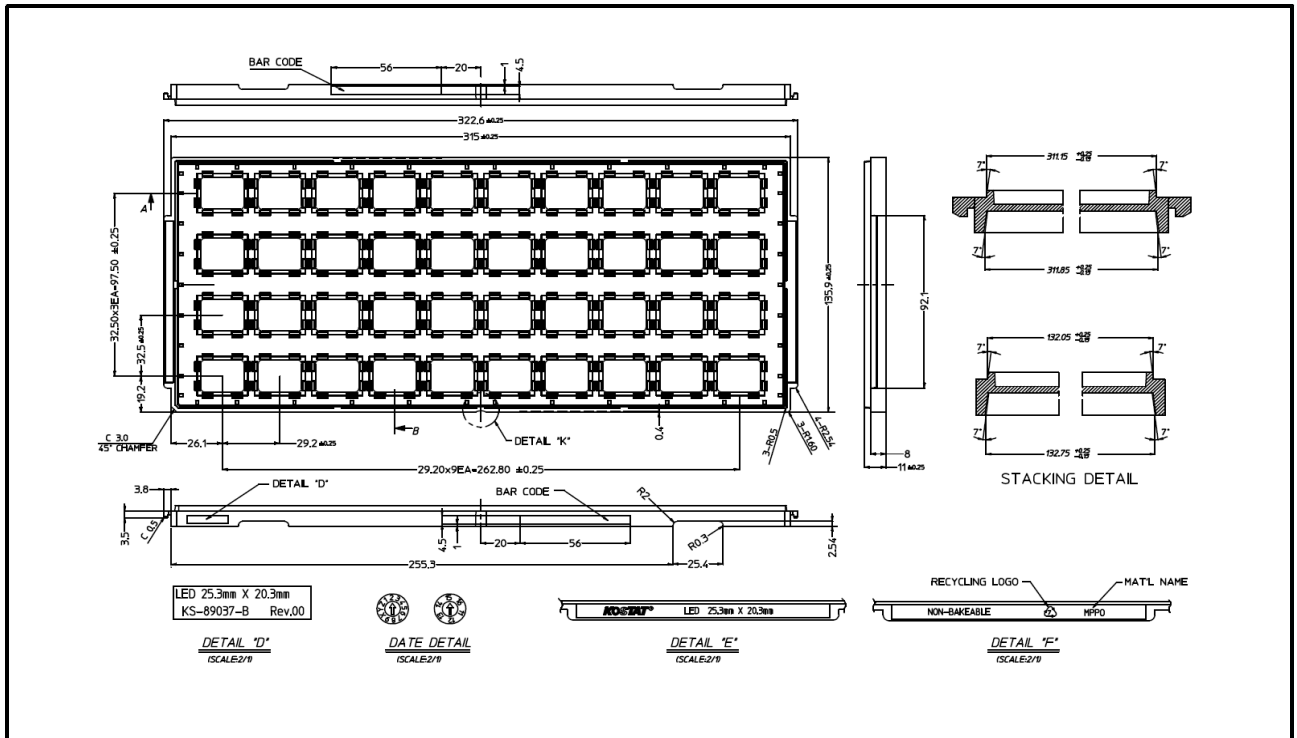

10. Aluminum Bag Dimension

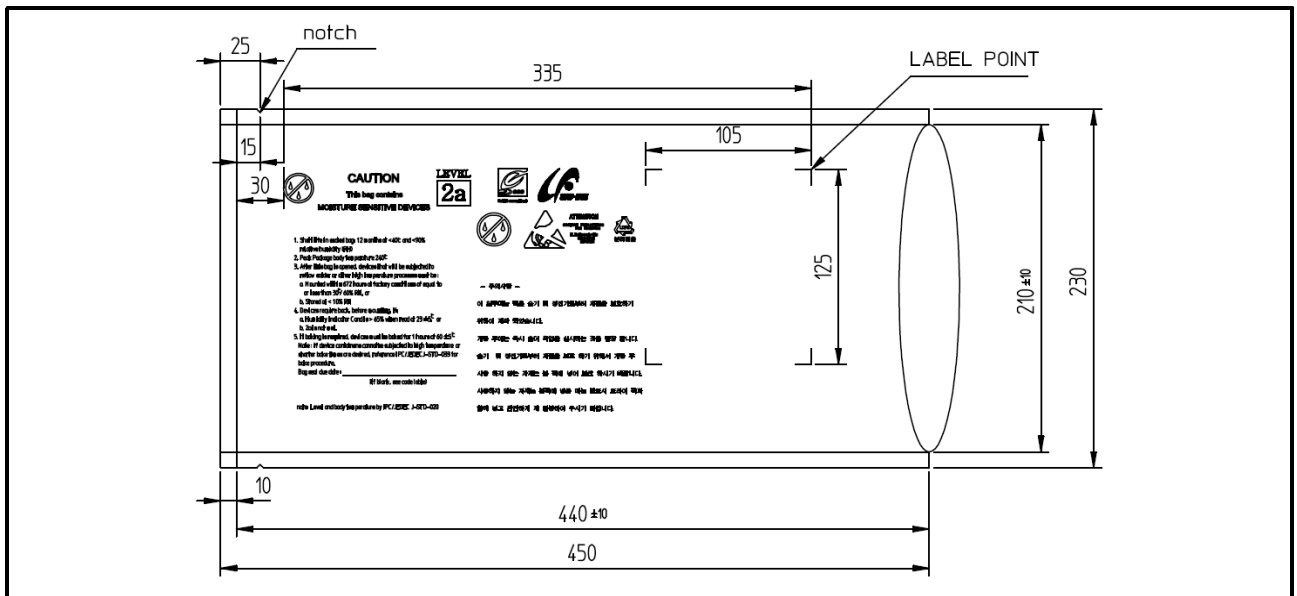

Silica gel & Humidity Indicator Card in Aluminum Bag



11. Box & Pad Dimension

1) Out BOX

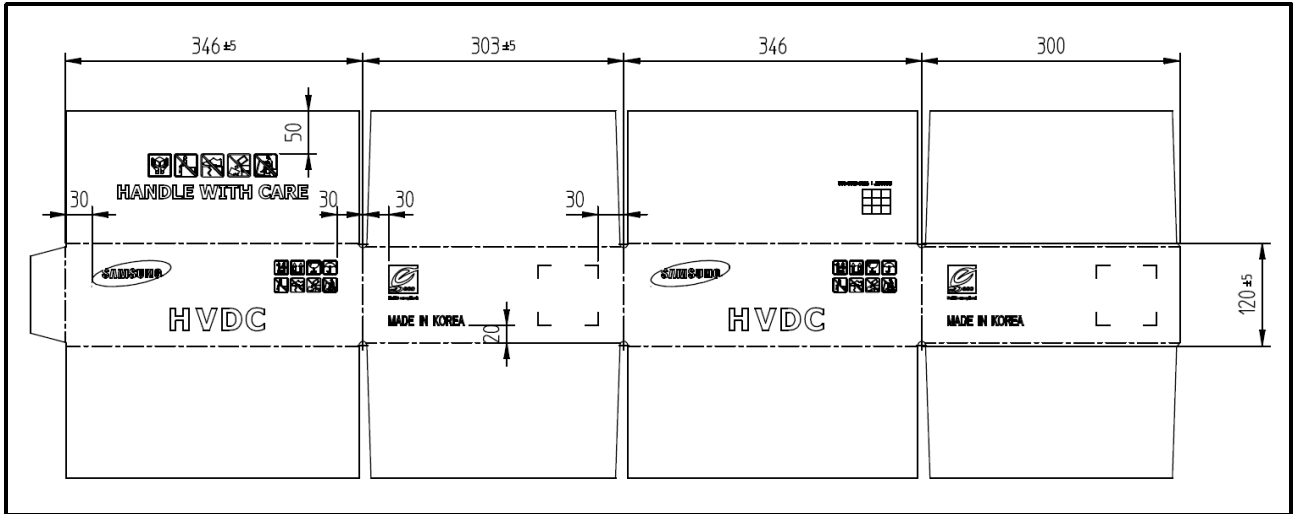

2) Inner BOX

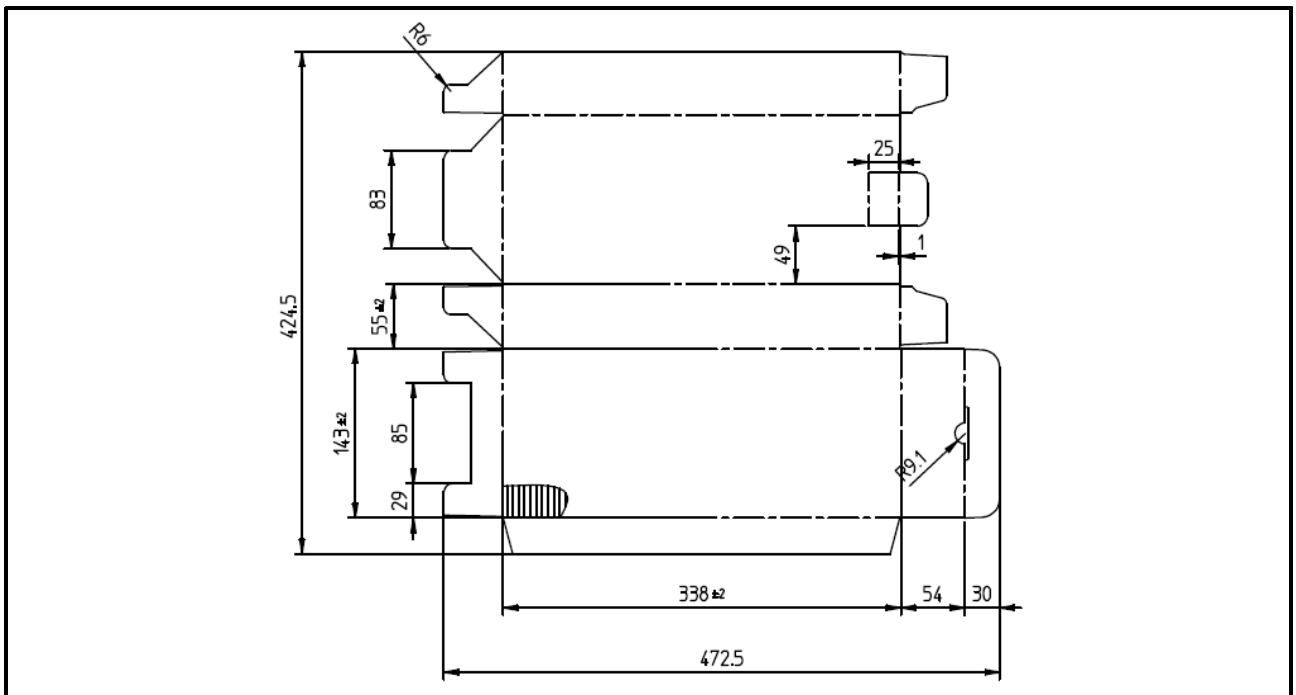

3) Pe-foam PAD

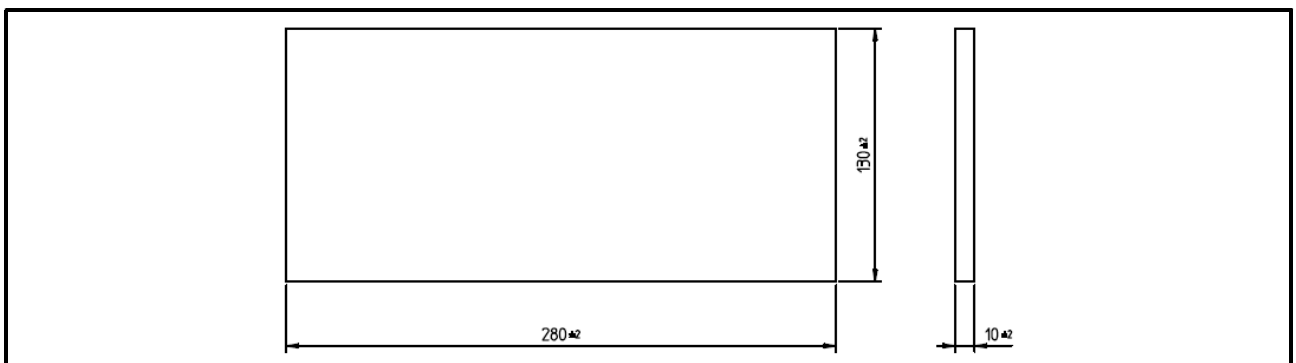

12. Packing Structure

1-1). Tray Packing (When 5 Trays)

Max Amount(pcs)		
Tray	Al Bag	Box
40	200	800

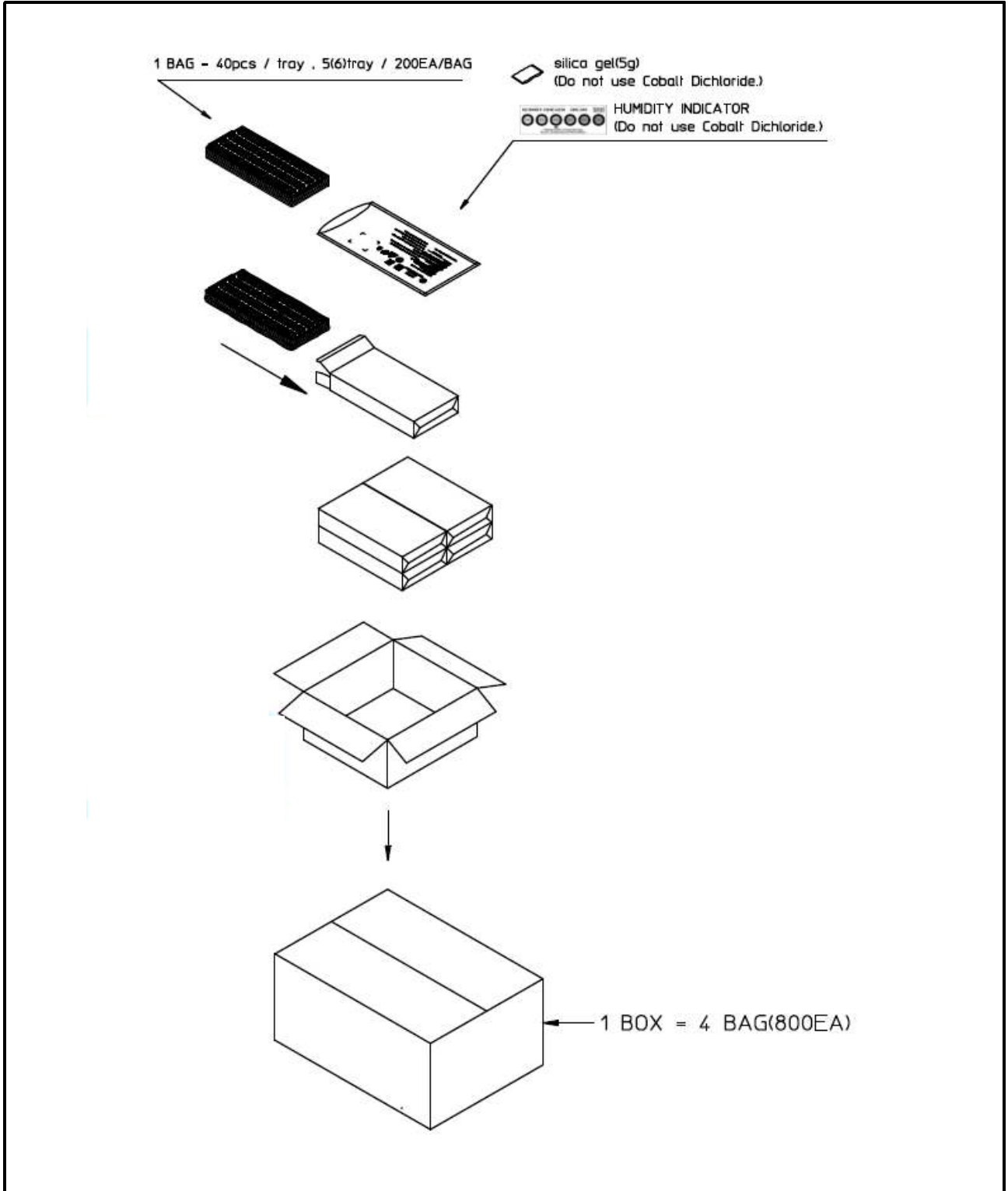

1-2). Tray Packing (When Less than 5 Trays)

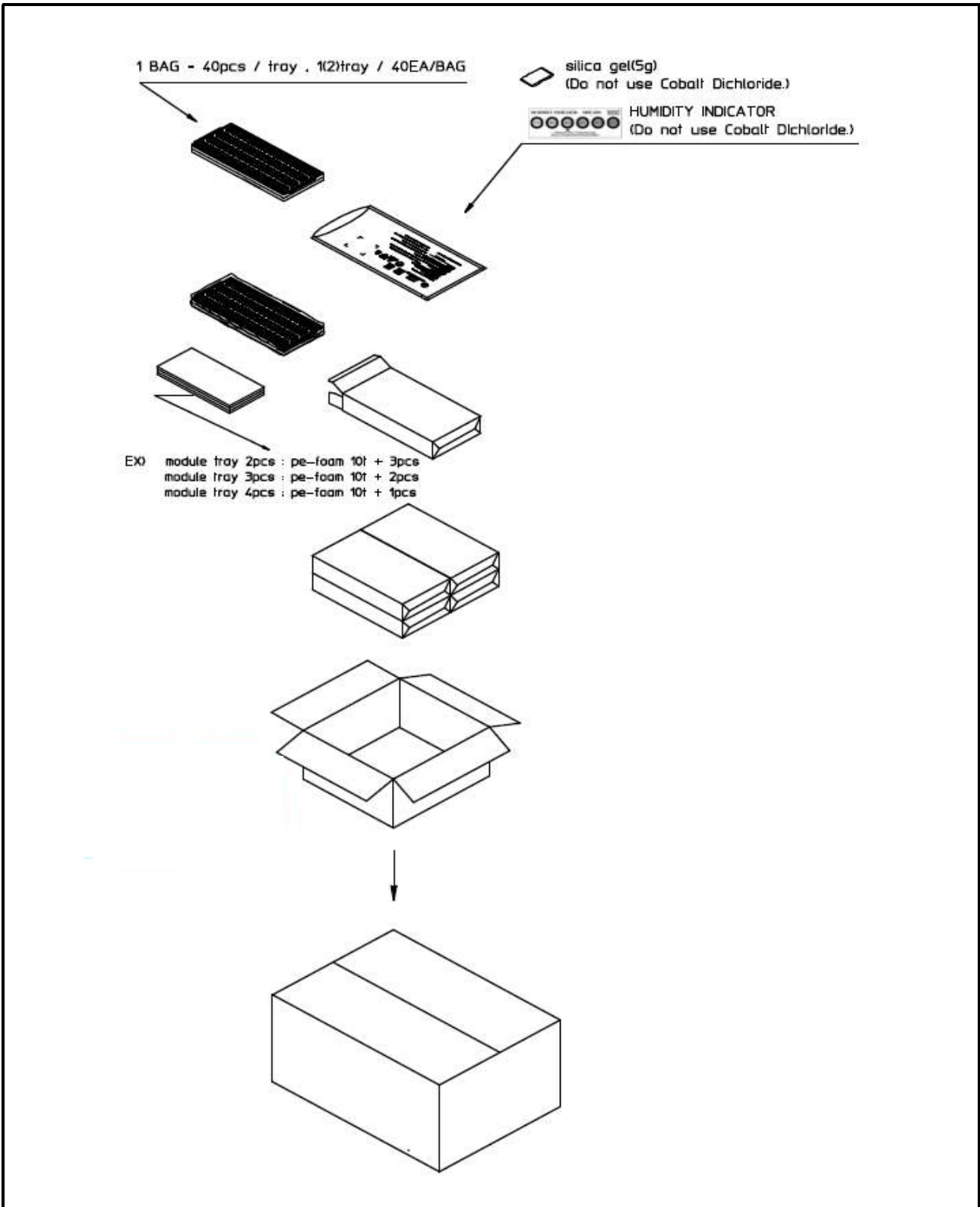

- EX) Module tray 2pcs : Pe-foam(10t) * 3pcs
- Module tray 3pcs : Pe-foam(10t) * 2pcs
- Module tray 4pcs : Pe-foam(10t) * 1pcs

13. Precaution for use

- 1) Shelf life in sealed bag : 12 months at $< 40^{\circ}\text{C}$ and $< 90\%$ relative humidity(RH)
- 2) Peak package body temperature : 240°C .
- 3) After this bag is opened, devices that will be subjected to reflow solder or other high temperature processes must be :
 - a. Mounted within 672 hours at factory conditions of equal to or less than 30°C / 60% RH, or
 - b. Stored at $< 10\%$ RH
- 4) Devices require bake, before mounting, if :
 - a. Humidity Indicator Card is $> 65\%$ when read at $23 \pm 5^{\circ}\text{C}$, or
 - b. 2a is not met.
- 5) If baking is required, devices must be baked for 1 hours at $60 \pm 5^{\circ}\text{C}$
Note : If device containers cannot be subjected to high temperature or shorter bake times are desired, reference IPC / JEDEC J-STD-033 for bake procedure.
- 6) The LEDs are sensitive to the static electricity and surge current.
It is recommended to use a wrist band or anti-electrostatic glove when handling the LEDs. If voltage exceeding the absolute maximum rating is applied to LEDs, it may cause damage or even destruction to LED devices.
Damaged LEDs may show some unusual characteristics such as increase in leakage current, lowered turn-on voltage, or abnormal lighting of LEDs at low current.

