

# Specification

## 规格书

Customer Name : \_\_\_\_\_

客户名称

Customer P/N : \_\_\_\_\_

客户品号

Refond P/N : RF-W7SP30TS-A44

公司型号

Sending Date: \_\_\_\_\_

供货日期

<input type="checkbox"/> Technical Reference 技术参考		<input type="checkbox"/> Sample 样品		<input checked="" type="checkbox"/> Mass Product 量产供货	
Customer approval 客户审核			Refond approval 瑞丰审核		
Approval 核准	Audit 确认	Confirmation 制作	Approval 核准	Audit 确认	Confirmation 制作
<input type="checkbox"/> Qualified 接受		<input type="checkbox"/> Disqualified 不接受		Date : 日期:	

**Address:** 1-8th Floor, Building #1, 10th Industrial Zone, Tian Liao Community, Gong Ming Area, Guang Ming New District, Shenzhen, China.

**地址:** 深圳市光明新区公明办事处田寮社区第十工业区 1 栋一至八楼

**Tel/电话:** 0755-66839118

**Fax/传真:** 0755-66839300

**Web/网址:** [www.refond.com](http://www.refond.com)

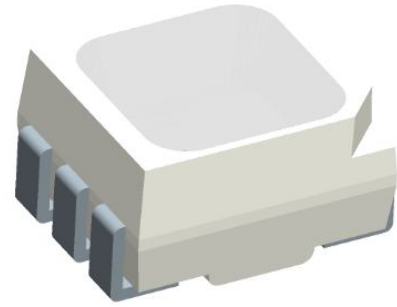
**RF-W7SP30TS-A44****Features 特征**

- PLCC-6 Package. PLCC-6 封装
- Extremely wide viewing angle. 发光角度大
- Suitable for SMT assembly and solder process. 适用于SMT组装和焊接工艺
- Available on tape and reel. 适用于载带及卷轴
- Moisture sensitivity level: Level 3. 防潮等级 Level 3
- Package: Min: 500 pcs/reel, Max: 2000 pcs/reel. 包装每卷数量最小500 pcs, 最大2000 pcs.

**Description 描述**

- The Red source color devices are made with AlGaInP on Substrate Light Emitting Diode  
红光LED由AlGaInP四种元素芯片激发而成
- The Green source color devices are made with InGaN on Substrate Light Emitting Diode  
绿光LED由InGaN三种元素芯片激发而成
- The Blue source color devices are made with InGaN on Substrate Light Emitting Diode  
蓝光LED由InGaN三种元素芯片激发而成

**Applications 应用**

- Optical indicator. 光学指示
- Indoor display. 室内显示
- Landscape lighting, lamp belt. 景观照明, 灯带等
- General suitable applications. 其他适合的应用



### Package Dimension

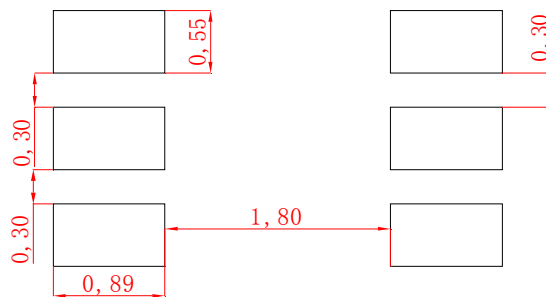
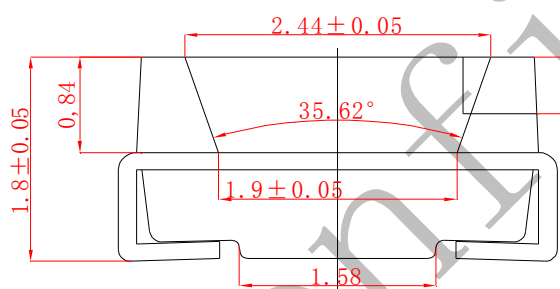
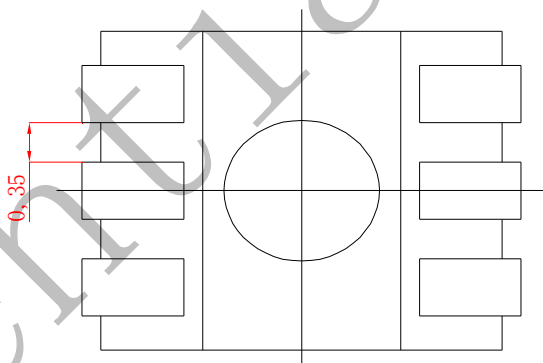
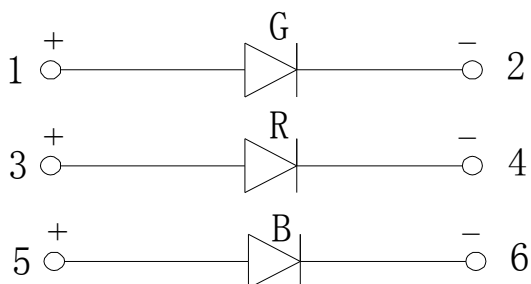
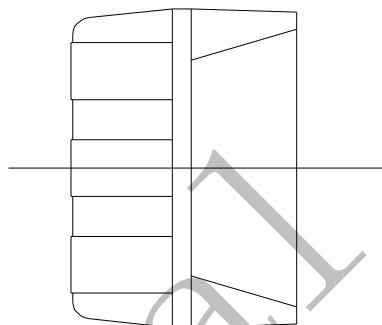
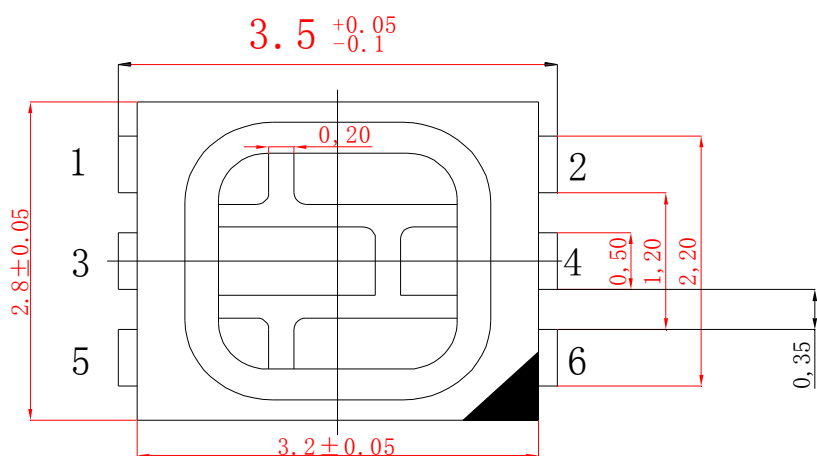

Soldering Patterns

外形尺寸: 3.5\*2.8\*1.8mm

#### NOTES:

1. All dimensions units are millimeters. (所有尺寸标注单位为毫米)
2. All dimensions tolerances are  $\pm 0.2$ mm unless otherwise noted. (除特别标注外, 所有尺寸公差为 $\pm 0.2$ 毫米)



**Electrical / Optical Characteristics at Ts=25°C 电性与光学特性**

Item 项目		Symbol 符号		test condition 测试条件	Value			unit 单位
					Min.	Max.	Typ.	
Forward Voltage	Rank B1	R	Vf	IF=20mA	1.8	1.9	2.1	V
	Rank B2				1.9	2.0		V
	Rank C1				2.0	2.1		V
	Rank C2				2.1	2.2		V
	Rank D1				2.2	2.3		V
	Rank D2				2.3	2.4		V
	Rank F2	G&B			2.7	2.8	G=3.0 B=3.1	V
	Rank G1				2.8	2.9		V
	Rank G2				2.9	3.0		V
	Rank H1				3.0	3.1		V
	Rank H2				3.1	3.2		V
	Rank I2				3.2	3.3		V
Dominant wavelength	Rank D00	R	Wld	IF=20mA	615.0	620.0	621.5	nm
	Rank E00				620.0	625.0		nm
	Rank F00				625.0	630.0		nm
	Rank D00	G			515.0	520.0	521.0	nm
	Rank E00				520.0	525.0		nm
	Rank F00				525.0	530.0		nm
	Rank D00	B			465.0	470.0	467.0	nm
Rank E00	470.0		475.0	nm				
Luminous intensity	Rank K10	R	IV	IF=20mA	530	650	795	mcd
	Rank K20				650	800		mcd
	Rank L10				800	1000		mcd
	Rank M10	G			1200	1500	1800	mcd
	Rank M20				1500	1800		mcd
	Rank N10				1800	2300		mcd
	Rank I20	B			280	350	480	mcd
	Rank J10				350	430		mcd
	Rank J20				430	530		mcd
	Rank K10				530	650		mcd
Reverse Current R			IR	VR=5V	---	10	---	uA
Reverse Current G			IR	VR=5V	---	10	---	uA
Reverse Current B			IR	VR=5V	---	10	---	uA
Viewing Angle R			2Θ1/2	IF=20mA	---	---	120	Deg
Viewing Angle G			2Θ1/2	IF=20mA	---	---	120	Deg
Viewing Angle B			2Θ1/2	IF=20mA	---	---	120	Deg
Thermal resistance	R		Rth(j-s)	IF=20mA	--	--	45	°C/W
Thermal resistance	G		Rth(j-s)	IF=20mA	--	--	65	°C/W
Thermal resistance	B		Rth(j-s)	IF=20mA	--	--	55	°C/W

**Mix the white light specifications at Ts=25°C 混白光规格**

Item 项目	Symbol 符号		test condition 测试条件	Value			unit 单位
				Min.	Max.	Typ.	
Luminous intensity	IV	Rank ND0	IF=20mA	2550	2800	3110	mcd
		Rank OA0		2800	3150		mcd
		Rank OB0		3150	3500		mcd

**Absolute Maximum Ratings at Ts=25°C 绝对最大值**

Parameter (参数)	Symbol (符号)	Rating (值)	Units (单位)
Power Dissipation (功耗)	Pd	R: 72+G: 102+B: 102	mW
Forward Current (正向电流)	IF	R: 30+G: 30+B: 30	mA
Peak Forward Current (峰值电流)	IFP	100	mA
Reverse Voltage (反向电压)	VR	5	V
Electrostatic Discharge(HBM) (静电)	ESD	2000	V
Operating Temperature (操作温度)	Topr	-40 ~ +85	°C
Storage Temperature (储存温度)	Tstg	-40 ~ +100	°C
junction temperature (结温) R	Tj	95	°C
junction temperature (结温) G	Tj	95	°C
junction temperature (结温) B	Tj	95	°C

Note: 1. 1/10 Duty cycle, 0.1ms pulse width. 脉宽0.1ms, 周期1/10.

2. The above forward voltage measurement allowance tolerance is  $\pm 0.1V$ . 以上所示电压测量误差 $\pm 0.1V$ .

3. The above wavelength measurement allowance tolerance is  $\pm 1nm$ . 以上所示波长测量误差 $\pm 1nm$ .

4. the above luminous intensity measurement allowance tolerance  $\pm 10\%$ . 上述发光强度的测试允许公差为 $\pm 10\%$ .

5. The below color coordinates measurement allowance tolerance is 0.003. 以下所示坐标测量误差0.003

6. Care is to be taken that power dissipation does not exceed the absolute maximum rating of the product. 使用功率不能超过规定的最大值。

7. All measurements were made under the standardized environment of Refond. 所有测试都是基于瑞丰现有的标准测试平台。

8. When the LEDs are in operation the maximum current should be decided after measuring the package temperature, junction temperature should not exceed the maximum rate. LED 使用的最大电流需要根据散热条件确定, 结温不能超过最大值。



Typical optical characteristics curves 典型光学特性曲线

Fig.1-Forward Voltage Vs. Forward Current  
伏安特性曲线

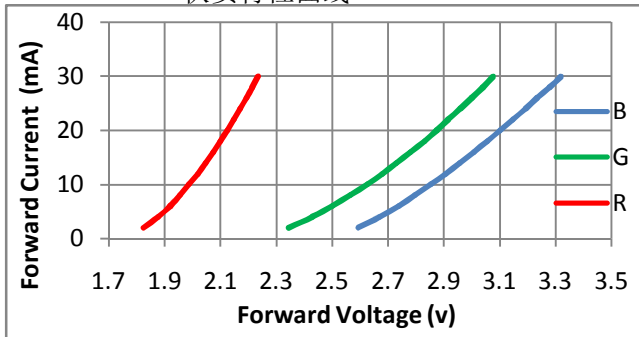

Fig.2-Forward Current Vs. Relative Intensity  
正向电流与相对光强特性曲线

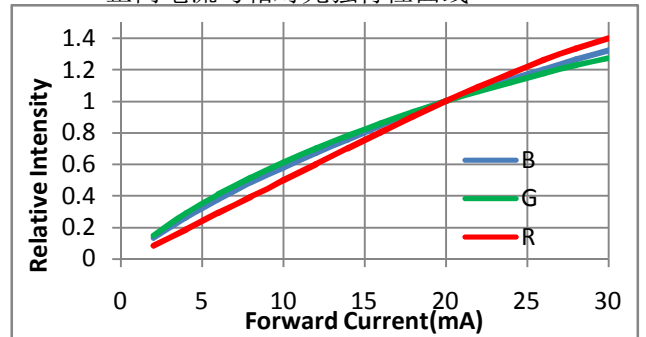

Fig.4-Pin Temperature Vs. Forward Current  
引脚温度与正向电流特性曲线

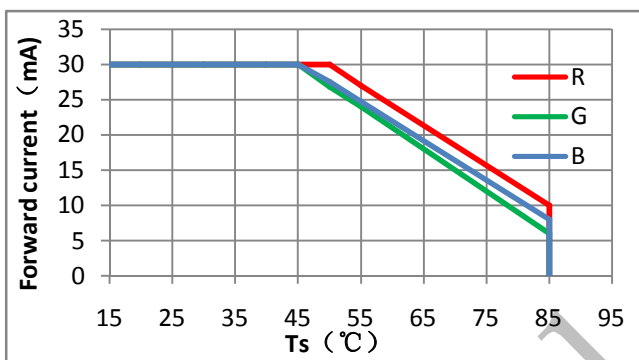

Fig.4- R-Dominate wavelength Vs. Forward Current  
红光主波长与正向电流特性曲线

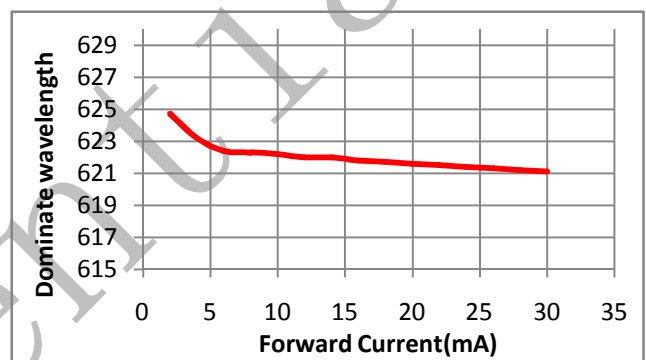

Fig.5- G-Dominate wavelength Vs. Forward Current  
绿光主波长与正向电流特性曲线

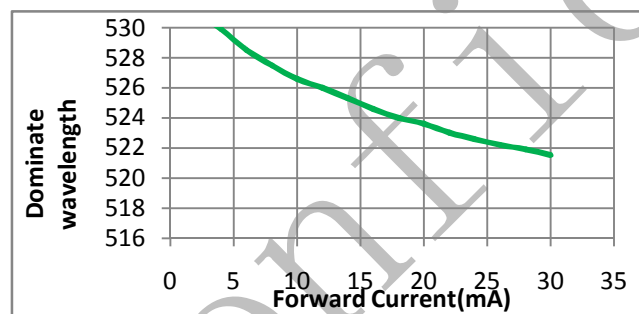

Fig.6- B-Dominate wavelength Vs. Forward Current  
蓝光主波长与正向电流特性曲线

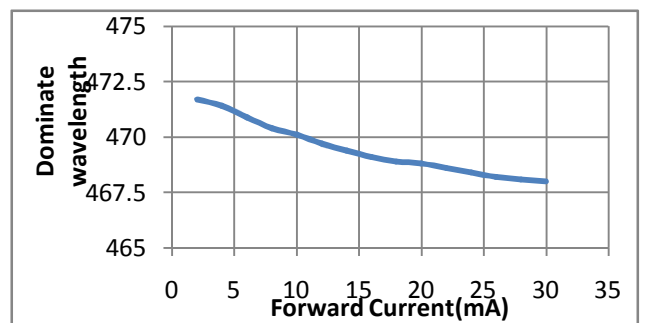

Fig.7- Spectrum Distribution  
光谱分布特性曲线

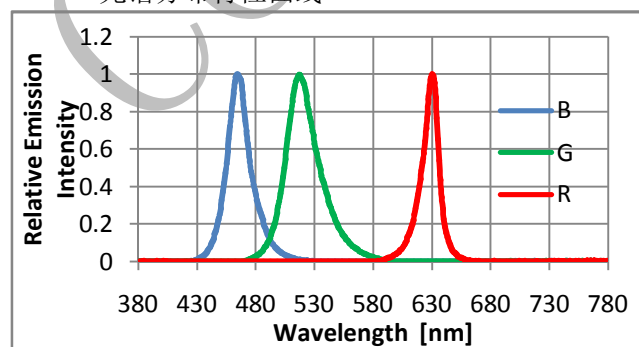
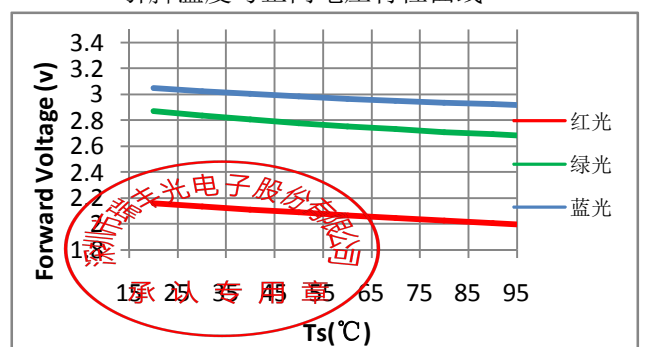

Fig.8-Pin Temperature Vs. Forward Voltage  
引脚温度与正向电压特性曲线



Typical optical characteristics curves 典型光学特性曲线

Fig.9- Pin Temperature Vs. Dominate wavelength  
引脚温度与主波长曲线

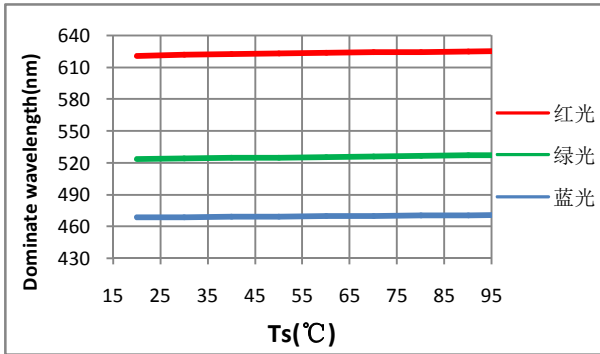

Fig.10- luminous intensity Vs. Pin Temperature  
发光强度与引脚温度曲线

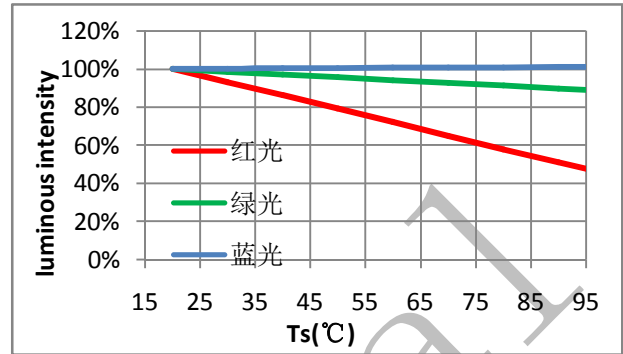
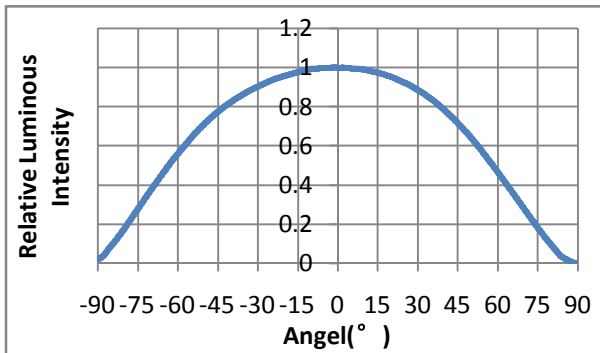

Fig.11- Radiation diagram  
辐射特性曲线



Note:备注

All the parameters and standards in the specification are based on Refond standard test platform.

规格书中所有参数和标准都是基于瑞丰的标准测试平台。







■ Label Form Specification 标签规格

PART NO. <u>cinvcod</u>	
SPEC NO. <u>cspecno</u>	
LOT NO. <u>lotno</u>	
BIN CODE: <u>zbin</u>	
<u>qc r</u>	
<u>qc g</u>	
<u>qc b</u>	
QTY: <u>qty</u>	
DATE: <u>date</u>	

PART NO.	Part Number
SPEC NO.	Spec Number
LOT NO.	Lot Number
BIN CODE	Bin Code
IV	Luminous intensity
WLD	Wavelength Bin
VF	Forward Voltage
QTY	Packing Quantity
DATE	Made Date

■ Moisture Resistant Packing Process 防潮包装过程

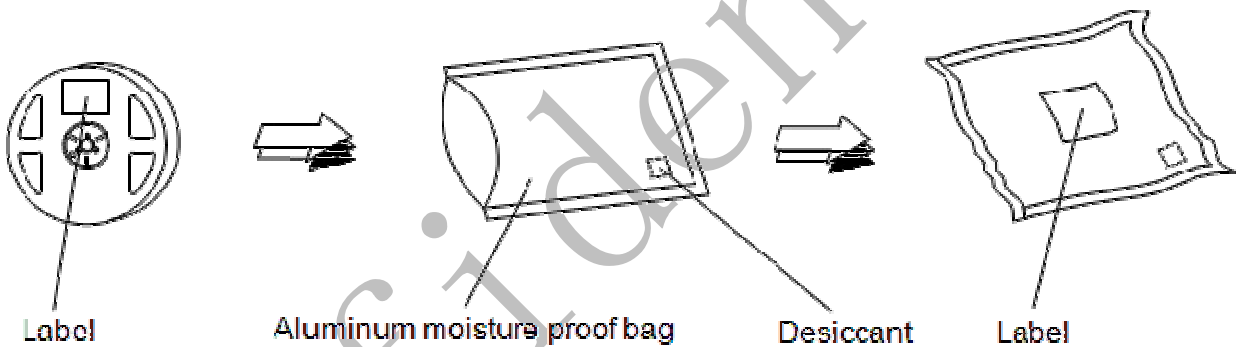

■ Cardboard Box 纸箱

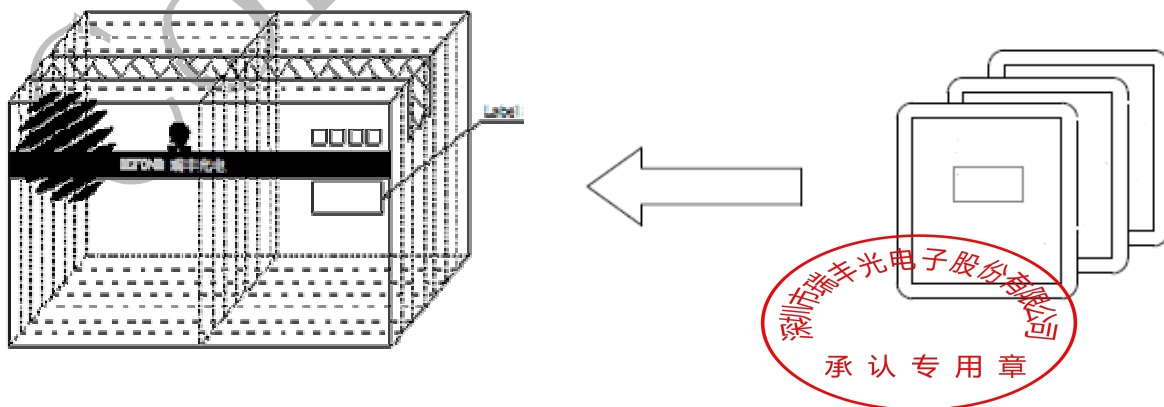

**Reliability Test Items And Conditions** 信赖性测试项目及条件

Test Items 项目	Ref.Standard 参考标准	Test Condition 测试条件	Time 时间	Quantity 数量	Ac/Re 接收/拒收
Reflow 回流焊	JESD22-B106	Temp:260°C max T=10 sec	2times.	10Pcs	0/1
Thermal Shock 冷热冲击	JESD22-A106	-40°C 15min ↑↓ 100°C 15min	100 cycle	10Pcs	0/1
High Temperature Storage 高温保存	JESD22-A103	Temp:100°C	500Hrs.	10Pcs	0/1
Low Temperature Storage 低温保存	JESD22-A119	Temp:-40°C	500Hrs.	10Pcs	0/1
Life Test 常温通电	JESD22-A108	Ta=25°C IF=20mA	1000Hrs.	10Pcs	0/1
High Temperature High Humidity Life Test 高温高湿通电	JESD22-A101	60°C / 90%RH IF=20mA	500Hrs.	10Pcs	0/1

**Criteria For Judging Damage** 失效判定标准

Test Items 项目	Symbol 符号	Test Condition 测试条件	Criteria For Judgement 判定标准	Applicable project 适用项目
Forward Voltage 正向电压	Vf	IF=20mA	≤ ± 10%	Reflow Temperature Cycle High and Low Temperature Storage Life Test
Luminous intensity 光强-R	IV	IF=20mA	Maintenance ≥ 70% 光强维持率	
Luminous intensity 光强-G	IV	IF=20mA	Maintenance ≥ 70% 光强维持率	
Luminous intensity 光强-B	IV	IF=20mA	Maintenance ≥ 50% 光强维持率	
Lamp bead light test 灯珠点亮测试	/	IF=20mA	No open circuit, shortcircuit or flicke 无开路,短路, 闪变	High Temperature High Humidity Life Test

U.S.L: Upper standard level 规格上限      L.S.L: Lower standard level 规格下限

Note: 备注

The Reliability tests are based on Refond existing test platform. 信赖性测试基于瑞丰现有的测试平台。

The technical information shown in the data sheets are limited to the typical characteristics and circuit examples of the referenced products. It does not constitute the warranting of industrial property nor the granting of any license. 以上技术数据仅为产品的典型值，只作为参考，不作为任何应用条件及应用方式的保证。

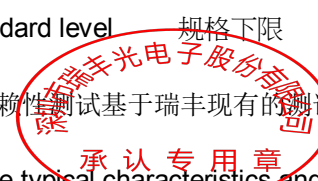

SMT Reflow Soldering Instructions SMT回流焊说明

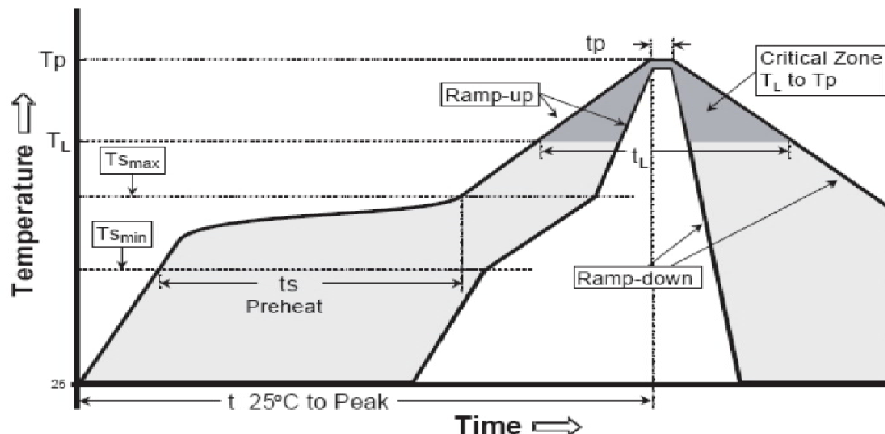

平均升温速度 (T <sub>Smax</sub> 至T <sub>p</sub> )	最高 3 ° C/ 秒
预热: 最低温度 (T <sub>Smin</sub> )	150 ° C
预热: 最高温度 (T <sub>Smax</sub> )	200 ° C
预热: 时间 (t <sub>Smin</sub> 至t <sub>Smax</sub> )	60 - 120 秒
限时维持高温: 温度 (T <sub>L</sub> )	217 ° C
限时维持高温: 时间 (t <sub>L</sub> )	最多60 秒
峰值 / 分类温度 (T <sub>p</sub> )	260 ° C
限时峰值分类温度:时间 (t <sub>p</sub> )	最多10 秒
与实际峰值温度 (t <sub>p</sub> ) 低 5 ° C 以内的保持时间	最多30 秒
降温速度	最高 6 ° C/ 秒
25 ° C 升至峰值温度所需时间	最多 8 分钟

- 1.Reflow soldering should not be done more than two times. In the case of more than 24 hours passed soldering after first, LEDs will be damaged. 回流焊次数不可以超两次，两次回流焊时间间隔如果超过24小时，LED可能由于吸湿而损坏
- 2.When soldering , do not put stress on the LEDs during heating当焊接时，不要在材料受热时用力压胶体表面。

■ Soldering Iron 烙铁焊接

- 1.When hand soldering, keep the temperature of iron below less 300°C less than 3 seconds  
当手工焊接时，烙铁的温度必须小于300°C，时间不可超过3秒。
- 2.The hand solder should be done only one time.手工焊接只可焊接一次。

■ Repairing 修补

Repair should not be done after the LEDs have been soldered. When repairing is unavoidable,a double-head soldering iron should be used (as below figure). It should be confirmed in advance whether the characteristics of LEDs will or will not be damaged by repairing. LED回流焊后不应该修复，当必须修复时，必须使用双头烙铁，而且事先应确认此种方式会不会损坏LED本身的特性。

■ Cautions 注意事项

- 1.The encapsulated material of the LEDs is silicone. Therefore the LEDs have a soft surface on the top of package. The pressure to the top surface will be influence to the reliability of the LEDs. Precautions should be taken to avoid the strong pressure on the encapsulated part. So when usethe picking up nozzle, the pressure on the silicone resin should be proper. LED封装胶为硅胶，表面较软，用力按压胶体表面会影响LED可靠性，因此应采取预防措施避免在按压器件，当使用吸嘴时，胶体表面的压力应是恰当的。
2. Components should not be mounted on warped (non coplanar) portion of PCB. After soldering, do not warp the circuit board.LED灯珠不要焊接在弯曲的PCB板上，焊接之后，也不要弯折线路板。
3. Do not apply mechanical force or excess vibration during the cooling process to normal temperature after soldering. Do not rapidly cool device after soldering. 回流焊之后冷却过程中，不要对材料实加外力，也不要震动，回流焊后，不要采用激剧冷却的方式。

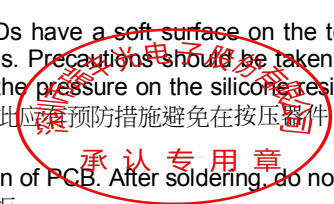

## Handling Precautions 使用注意事项

1>.LED operating environment and sulfur element composition cannot be over 100PPM in the LED mating usage material. This is provided for informational purposes only and is not a warranty or endorsement.LED工作环境及与LED适配的材料中，硫元素及化合物成份不可超过100PPM，单一的溴元素含量要求小于900PPM，单一氯元素含量要求小于900PPM，溴元素与氯元素总含量必须小于1500PPM（检测含量为与LED直接接触面上元素含量）。

2>.VOCs (Volatile organic compounds) emitted from materials used in the construction of fixtures can penetrate silicone encapsulants of LEDs and discolor when exposed to heat and photonic energy. The result can be a significant loss of light output from the fixture. Knowledge of the properties of the materials selected to be used in the construction of fixtures can help prevent these issues. Refond advises against the use of any chemicals or materials that have been found or are suspected to have an adverse affect on device performance or reliability. To verify compatibility, Refond recommends that all chemicals and materials be tested in the specific application and environment for which they are intended to be used. Attaching LEDs, do not use adhesives that outgas organic vapor. 应用套件中的挥发性物质会渗透到LED内部，可能对LED性能或者可靠性不利，在通电情况下会加剧影响。因此客户需提前验证，避免套件材料或其他组装原物料存在未经验证的挥发性物质，针对特定的用途和使用环境，瑞丰建议对所有的物质和材料进行相容性的测试。

3>.Handle the component along the side surface by using forceps or appropriate tools; do not directly touch or Handle the silicone lens surface, it may damage the internal circuitry.

通过使用适当的工具从材料侧面夹取，不可直接用手或尖锐金属压胶体表面，它可能会损坏内部电路。

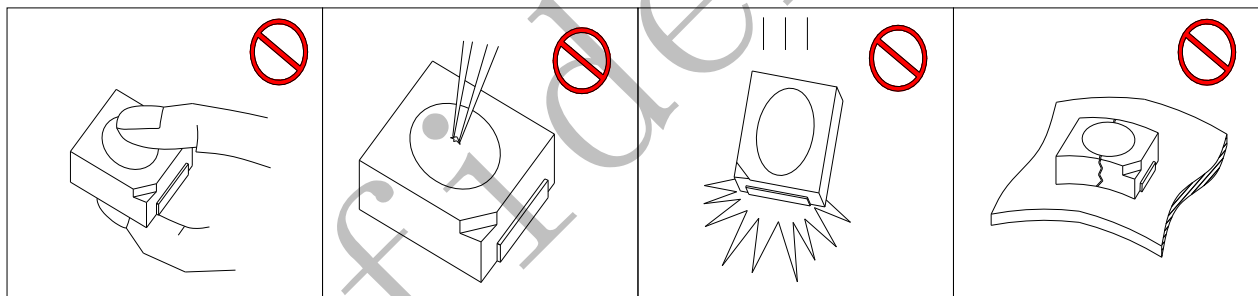

4>. In designing a circuit,the current through each LED must be exceed the absolute maximum rating specified for each LED.In the meanwhile,resistors for protection should be applied,otherwise slight voltage shift will cause big current change,burn out may happen. The driving circuit must be designed to allow forward voltage only when it is ON or OFF.If the reverse voltage is applied to LED, migration can be generated resulting in LED damage.设计电路时，通过LED的电流不能超过规定的最大值，同时，还需使用保护电阻，否则，微小的电压变化将会引起较大电流变化，可能导致产品损毁。电路设计必须保证只有在开启或者关闭的时候出现正向电压的变化，不要施加反压，否则会损坏LED。

5>.Thermal Design is paramount importance because heat generation may result in the Characteristics decline,such as brightness decreased,Color change and so on.Please consider the heat generation of the LEDs when making the system design.LED容易因为自身的发热和环境的温度改变而改变，温度升高会降低LED发光效率，影响发光颜色，所以在设计时应充分考虑散热问题。

6> .Compared to standard encapsulants, silicone is generally softer, and the surface is more likely to attract dust , requiring special care during processing. In cases where a minimal level of dirt and dust particles cannot be guaranteed, a suitable cleaning solution must be applied to the surface after the soldering of components. Refond suggests using isopropyl alcohol for cleaning. In case other solvents are used, it must be assured that these solvents do not dissolve the package or resin. Ultrasonic cleaning is not recommended. Ultrasonic cleaning may cause damage to the LED. 与其他封装胶相比，硅胶通常较软，表面易吸附脏物，应用时应特别注意，当对产品洁净度要求较高时，应当采用恰当的清洗方式，我们推荐用异丙醇作清洗剂，如需要用到其他清洗剂，必须保证不会破坏封装体，超声清洗可能会对LED带来损害，不推荐这种清洗方式。

7> . Storage 储存

Conditions 种类		Temperature 温度	Humidity 湿度	Time 时间
Storage 储存	Before Opening Aluminum Bag 拆包前	≤30℃	≤75%	Within half Year from Delivery Date 半年内
	After Opening Aluminum Bag 拆包后	≤30℃	≤60%	24hours 24小时
Baking 烘烤		60±5℃	-	≥24hours 大于24小时

If the moisture absorbent material (silica gel) has faded away or the LEDs have exceeded the storage time, baking treatment should be performed after unpacking and based on the following condition: (65±5)℃ for above 24 hours.

如果干燥剂或包装失效，或者产品不符合以上有效储存条件，需拆包后进行烘烤，烘烤条件: 60±5℃，大于 24 小时。

If the package is flatulence or damaged, please notify the sales staff to assist.

如果包装袋胀气或者破损，请通知销售人员协助处理。

8> .Similar to most Solid state devices; LEDs are sensitive to Electro-Static Discharge (ESD) and Electrical Over Stress (EOS). LED为半导体器件，对静电敏感，生产和使用时需要做好防护。

9>.There should be Revalidated when there is any change on the use condition(like fixture type, raw material, Radiating change ) after the approval.产品承认后，如需变更使用环境条件（如：转换产品种类和结构），必须重新验证。

10>.When you have special quality requirement for the product, please kindly contact to our sales.对产品有特殊质量要求时，请提前咨询瑞丰的销售人员以取得相关信息。

11>.When using LED, clients shall pay attention to the defined specs and using environment requires.Refond will give no quality guarantee on the situation: if using in conditions that out of specs or over reference conditions which without verifying,客户在应用LED时，需参考此规格书参数及使用环境要求，未经验证情况超出参数或标准条件使用，瑞丰不作任何品质担保。

12>.The customer shall not disassemble or analyze the LEDs without having consent from Refond. When defective LEDs are found, the customer shall inform Refond in writing directly before disassembling or analysis.

在取得瑞丰的同意前，客户不应对产品进行拆解分析，如发现失效产品，请直接书面通知瑞丰。

13>.Other points for attention, please refer to our LED user manual.

其它注意事项请参照瑞丰 LED 使用手册。

### Declare 申明

This specification is written both in English and in Chinese and the latter is formal.

此规格书以中英文方式书写，若有冲突以中文版本为准。

Both the customers and Refond will agree on official specifications of supplied products before a customer's volume production. The specification is valid only after be signed. And Refond reserves the right to further modify the specification for technical reference and sample without noticing the customers.

在量产供货前，瑞丰需与客户签署一份正式的产品规格书并各自备份。规格书签核后方有效，对于作为技术参考以及送样时提供的规格书，瑞丰保留进一步修改而不需通知客户的权力。

Confidential

